

Saddle

Giuseppe Viganò



The tub-shaped back and armrests, which recall the shape of a saddle, and the padded seat make this sofa enjoyably soft. The aesthetic appeal is accentuated by the leather insert in the armrest, which defines its front and allows for a singular game of materials and combinations, to create a high-impact optical effect. The metal feet lighten the shape of the sofa, emphasising its contemporary allure. The extensive modularity of the sofa makes it possible to create multiple configurations, suitable for all spaces.

UPHOLSTERY

fabric

leather

CENTRAL ARMREST INSERT

Ponza leather

EXTERNAL ARMREST INSERT

fabric

Ponza leather (anilina: sand, clay, dark brown, cinnamon - nabuk: anthracite grey, dark brown, shell)

FEET (standard or conical)

mat white painted metal

mat anthracite grey painted metal

mat amaranth painted metal

mat brown painted metal

mat black painted metal

mat dove grey painted metal

mat lead painted metal

mat bronze painted metal

Divano - Sofa 270

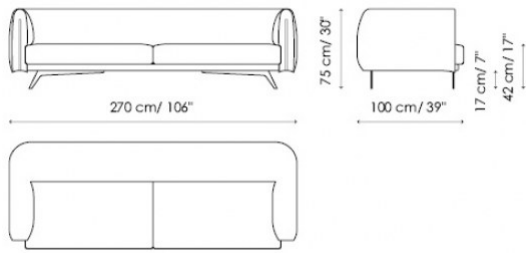

Divano - Sofa 230

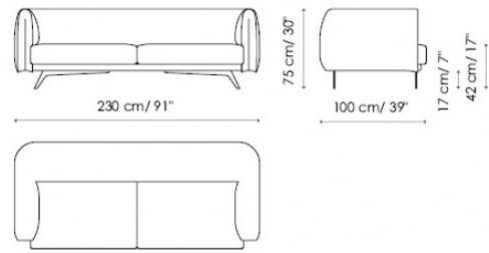

Divano - Sofa 190

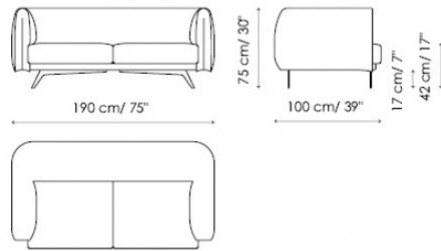

Terminale - End section sofa 250
dx - right

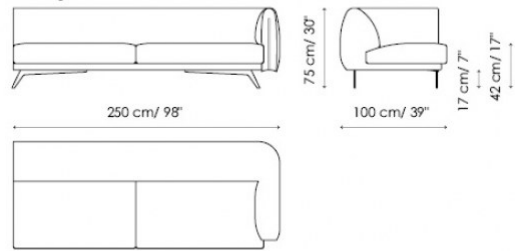

Terminale - End section sofa 210
dx - right

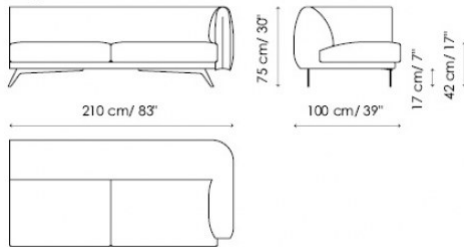

Terminale - End section sofa 170
dx - right

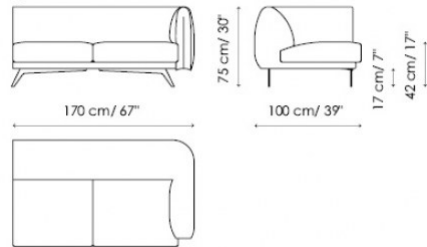

Chaise Longue 135x195
dx - right



Chaise Longue 115x175
dx - right



Penisola
dx - right

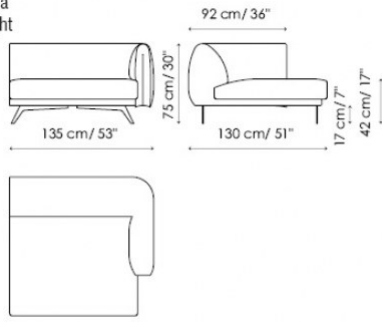

Meridiana
dx - right

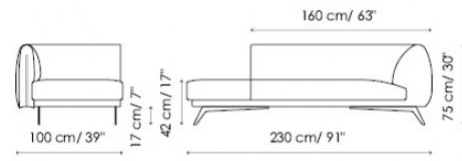

Angolo - Corner 130x130

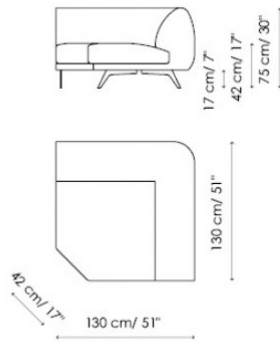

Poltrona - Armchair

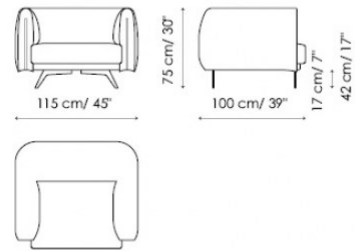

Pouf 100x100

