

Avarit

Giuseppe Viganò



Customisation is the key word that distinguishes the Avarit modular sofa collection. Customers can put together their desired composition starting with a fixed base and backrest, then adding the important seat cushions and down backrest that make up the actual soul of the sofa. In addition, it is possible to choose from an extensive range of upholstery covers in fabric and leather, which can be mixed and matched in total freedom. The feet are made of metal painted in anthracite grey, white, dove-grey, brown or black.

UPHOLSTERY:

fabric

leather

FEET:

matt anthracite grey painted metal

matt dove grey painted metal

matt brown painted metal

matt white painted metal

matt black painted metal

Divano 322 - variante A
Sofa

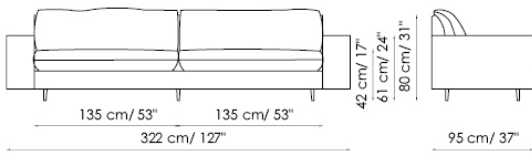

Divano 322 - variante B
Sofa

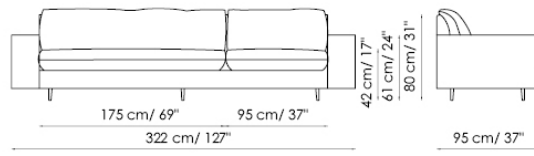

Divano 282 - variante A
Sofa

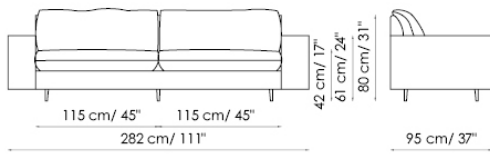

Divano 282 - variante B
Sofa

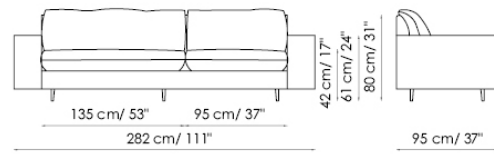

Divano 242
Sofa

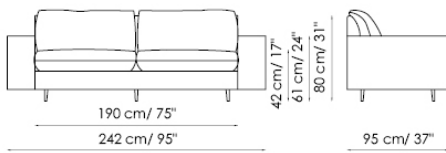

Divano 227
Sofa

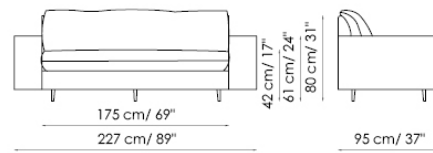

Divano 207
Sofa

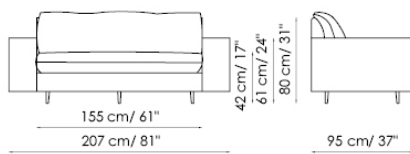

Divano 187
Sofa

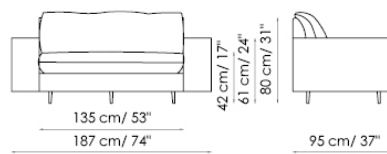

Terminale 256
End section sofa

sx
left

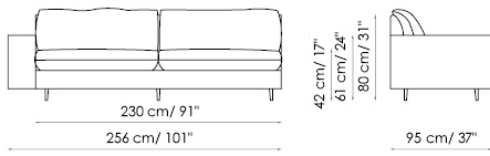

Terminale 216
End section sofa

sx
left

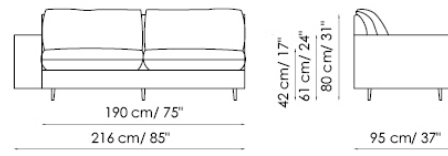

Terminale 201
End section sofa

sx
left

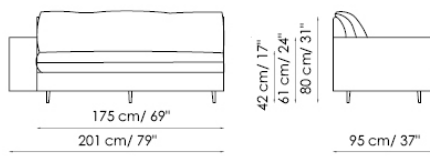

Centrale 270
Center section

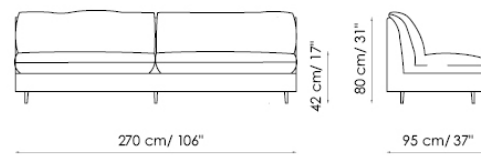

Centrale 230
Center section

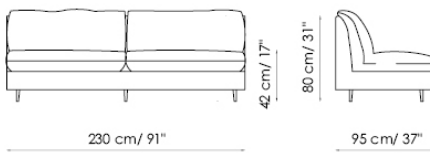

Centrale 190
center section

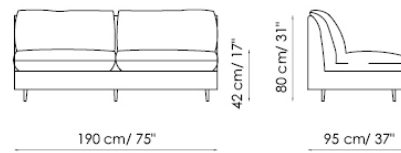

Centrale 175
Center section

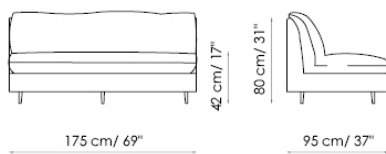

Centrale 155
Center section

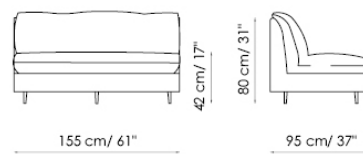

Centrale 135
Center section

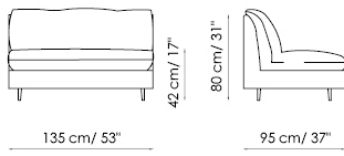

Centrale 115
center section

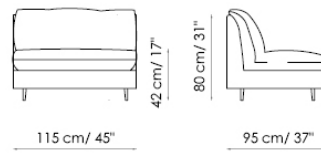

Centrale 95
center section

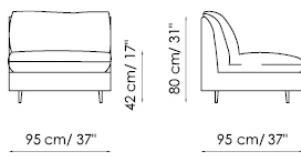

Chaise longue
sx
left

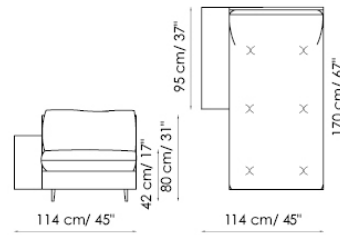

isola
sx
left

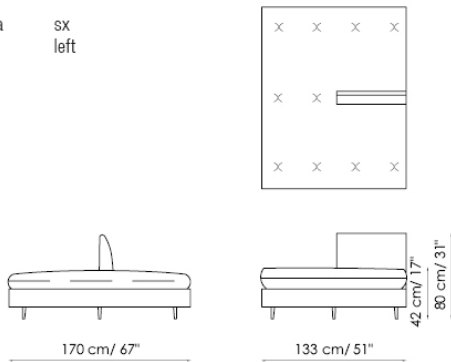

Pouf 95x95

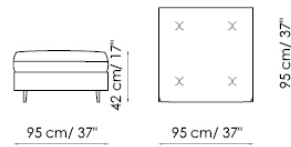

Pouf tavolino
pouf small table

