

Skid

Giuseppe Viganò



The sense of lightness is also enhanced by the fact that it is lifted off the ground thanks to the metal feet, which are available in two different shapes, either straight or a sliding base. The pure outline of Skid makes this sofa suitable for contemporary settings and more classical furnishings alike.

UPHOLSTERY:

fabric

Capri leather

Ischia leather

Procida leather

Ponza Nabuk leather

Ponza Anilina leather

FEET or SLIDING BASE

matt anthracite grey painted metal

matt dove grey painted metal

matt brown painted metal

matt white painted metal

matt black painted metal

matt amaranth painted metal

chromed metal

black nickel metal

copper-bronze finish metal

Divano 250
Sofa

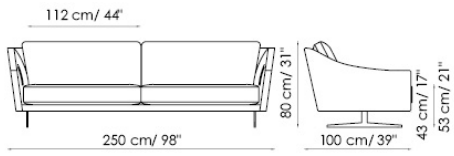

Divano 220
Sofa

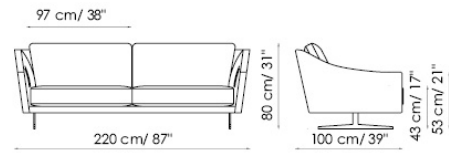

Divano 190
Sofa

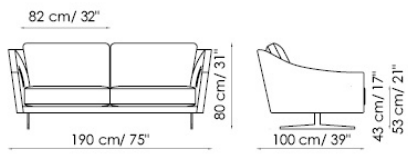

Terminale 230 dx
End section sofa right

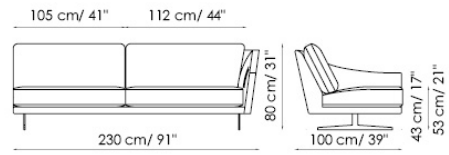

Terminale 200 dx
End section sofa right

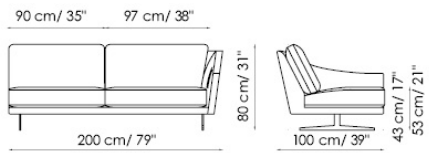

Terminale 170 dx
End section sofa right

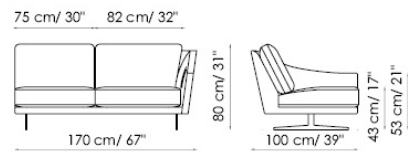

Angolare 250 dx
Corner sofa right

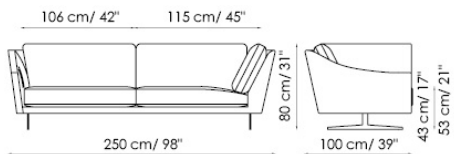

Angolare 220 dx
Corner sofa right

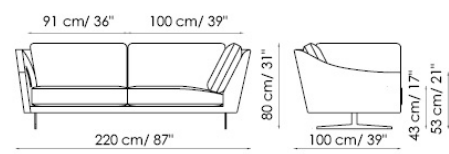

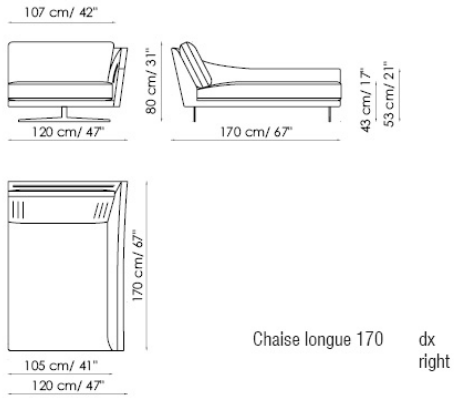

Chaise longue 170 dx right

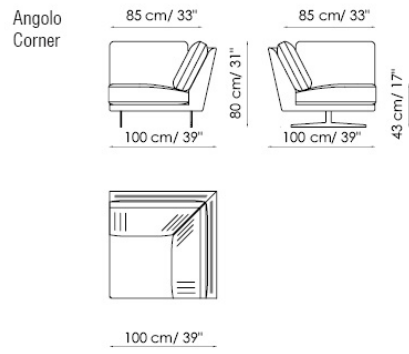

Meridiana 260 dx right

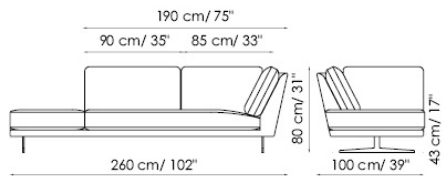

Meridiana 230 dx right

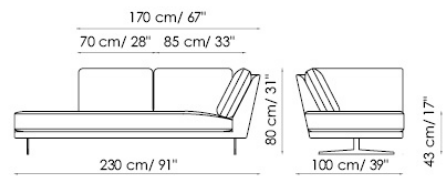

Dormeuse dx right

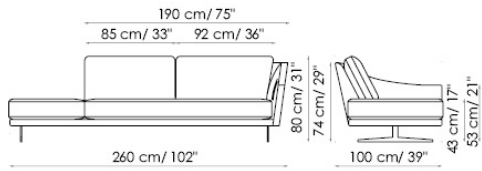

Pouf 87x87

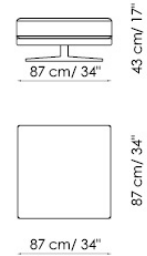

Pouf 120x70

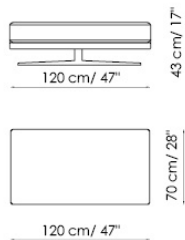

Pouf 120x120

