



Suita Sofa

The Suita sofa system combines light and slender volumes with an industrial and technological aesthetic. The geometrically precise body and cushions seem to float above the sleek, bridge-like aluminium legs, in what can be seen as a tribute to mid-century American design. The Suita sofa family encompasses a wide range of components. These can be used as independent elements or freely combined to adapt to all kinds of interior environments and furnishing needs.

The seat and back cushions come in a choice of firm or soft versions, and are optionally available with tufting.

Materials

- **Legs:** die-cast aluminium, polished or powder-coated.
- **Body:** webbed metal frame with moulded polyurethane foam.
- **Classic seat cushions, firm:** polyurethane foam and polyester fibre.
- **Classic seat cushions, soft and tufted:** polyurethane foam core and chamber cushion overlay (filled with polyurethane foam lozenges, latex and a mix of goose feathers and down).
- **Seat height:** 430 mm (315 mm with applied load, measured in accordance with EN 1335-1).
- **Classic back cushions, firm:** chamber cushions filled with polyurethane chips and feathers.
- **Classic back cushions, soft:** chamber cushions filled with polyurethane foam cubes and feathers.
- **Tufted back cushions:** chamber cushions filled with polyurethane foam cubes and ball fibres.
- **Pointed cushions 40 x 40 cm and 40 x 60 cm:** 100% feathers.
- **Pointed cushions 60 x 60 cm and 60 x 80 cm:** filled with polyurethane foam lozenges and feathers.
- **Bolsters:** filled with polyurethane foam lozenges and feathers.
- **Armrest cushions:** latex and siliconized fibers.
- **Covers:** removable.
- **Glides:** non-slip.
- **Head section:** moulded polyurethane foam with metal frame.
- **Shelf:** aluminium profile, powder-coated die-cast zinc with linoleum inlay.

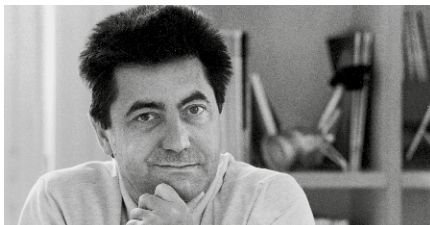

Antonio Citterio

The architect and designer Antonio Citterio, who lives and works in Milan, has collaborated with Vitra since 1988.

Together they have produced a series of

office chairs and various office systems, as well as products for the Vitra Home Collection. The Citterio Collection is constantly being expanded.

| | | | | | |
|-----|---------------------------------|-------|-----------------------|-------|-------------------------------|
| 1 | Suita | 10-13 | Suita family | 27-29 | Configurations and dimensions |
| 2-5 | Configurations | 14 | Accessories | 30-33 | Dimensions |
| 6-7 | Types of comfort and upholstery | 15 | Legs | | |
| 8-9 | Suita pillows | 16-24 | Colours and materials | | |
| | | 25-26 | Useful facts | | |

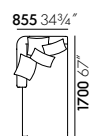

Suita Chaise Longue small, soft upholstery with pointed cushions, as well as two extra pointed cushions 40 x 40 cm, in Reed cover fabric (09 rose quartz)

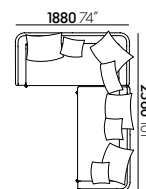

Suita Sofa 2-Seater and Suita Sofa 2-Seater open, soft upholstery with pointed cushions, in Dumet cover fabric (01 ivory)

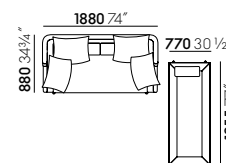

Suita Daybed and Suita Sofa 2-Seater, tufted soft upholstery with extra pointed cushions, in Mello cover fabric (03 cement)

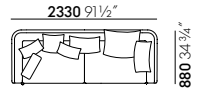

Suita Sofa 3-Seater, soft upholstery with pointed cushions, in Cosy 2 cover fabric (12 pale blue)

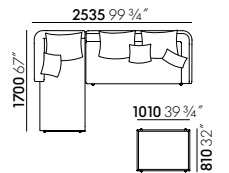

Suita Chaise Longue small, Suita Sofa 2-Seater open and Suita Ottoman, tufted soft upholstery with extra pointed cushions, in Corsaro cover fabric (01 pale blue melange)

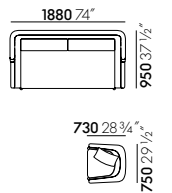

Suita Sofa 2-Seater with head section, firm upholstery with classic cushions and two armrest cushions, and Suita Club Armchair, in Reed cover fabric (07 canary)

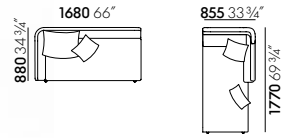

Suita Sofa 2-Seater open, Chaise Longue small with head section and extra pointed cushions, tufted soft upholstery, in Linho cover fabric (07 olive)

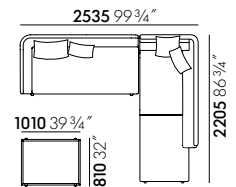

Suita Sofa 2-Seater open, with armrest cushions, Suita Chaise Longue large with extra pointed cushions, firm upholstery with classic cushions, and Suita Ottoman, in Olimpo cover fabric (11 atlantic)

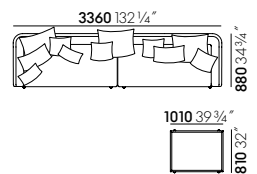

Two Suita Sofa 2-Seater open, soft upholstery with pointed cushions, and Suita Ottoman, in Dumet cover fabric (30 blackberry melange)

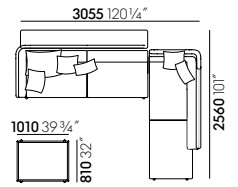

Suita Sofa 3-Seater open with shelf, Suita Chaise Longue large with head section, and Suita Ottoman, soft upholstery with pointed cushions, in Leather Premium (68 chocolate).

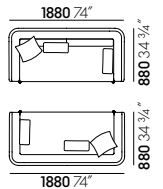

Two Suita Sofa 2-Seater, with bolster cushions, tufted soft upholstery, in Dumet cover fabric (33 carbon/black)

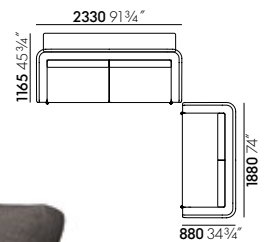

Suita Sofa 3-Seater with shelf and Suita Sofa 2-Seater, firm upholstery with classic cushions, in Corsaro cover fabric (12 graphite melange)

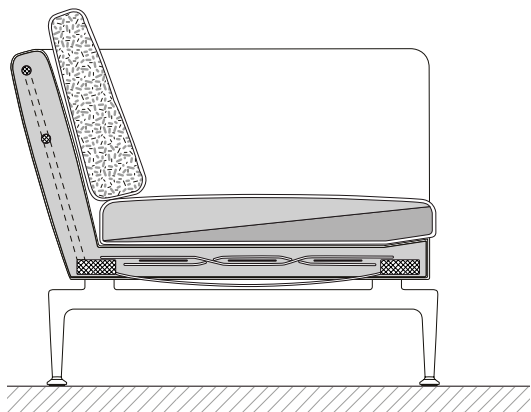

FIRM SEAT UPHOLSTERY AND FIRM CLASSIC CUSHIONS

The firm upholstery version provides resilient support, yielding only partially to the weight of the sitter. Its firm padding makes it easy to sit down and stand up.

The seat cushion comprises various foam layers, referred to as a sandwich construction. It is softer towards the back and firmer in front, thus providing enhanced support for the sitter.

The back cushions have a chamber cushion structure filled with a mixture of feathers and polyurethane rods.

The crisp appearance of the firm upholstery elements is characterised by linear, geometric forms.

Firm upholstery versions are available with covers in fabric or leather.

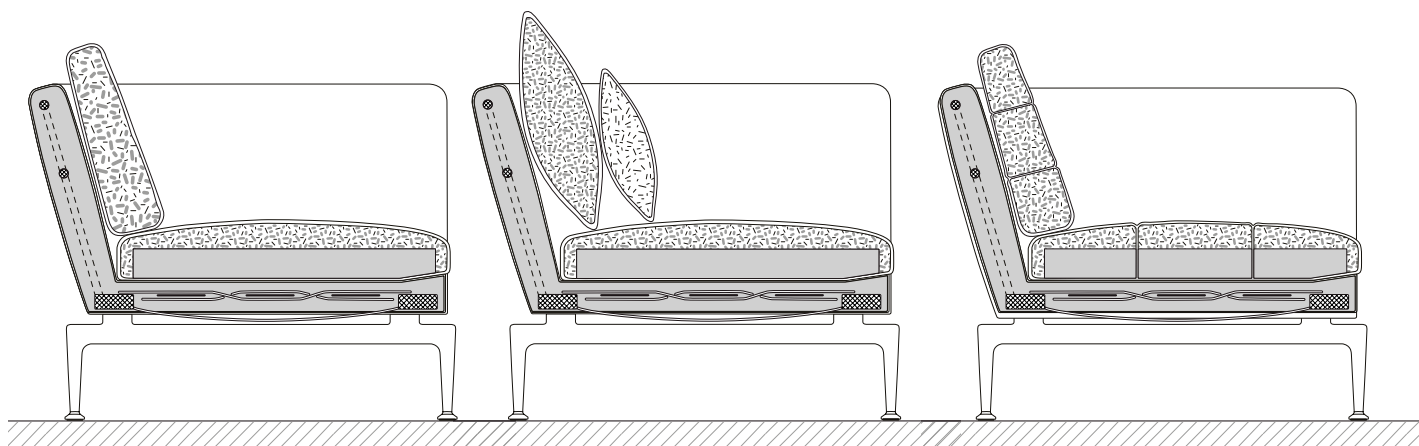

SOFT SEAT UPHOLSTERY, SOFT CLASSIC, POINTED AND TUFTED CUSHIONS

The soft upholstery is distinguished by its soft appearance and supple comfort. It allows the sitter to sink into the cushioning more deeply than with the firmer upholstery and creates an inviting place to lounge and relax.

The seat upholstery consists of a polyurethane foam core surrounded by a chamber cushion structure filled with polyurethane lozenges, latex and a mix of goose feathers and down.

The large classic back cushion as well as the tufted back cushions each have a chamber structure containing a blend of polyurethane cubes and ball fibres.

The stitched pointed cushions are filled with a mixture of feathers and polyurethane chips.

The appearance of the soft upholstery elements conveys a feeling of cosy comfort. The cover material is loosely fitted and forms gentle folds.

The tufted version only comes with fabric covers. Both the softly upholstered classic version and the variant with pointed cushions are available with covers in fabric or leather.

The elegant Suita sofa family encompasses a wide range of elements that can be freely combined with one another. A choice of different cushion types augments the adaptability of this system to fulfil personal needs and preferences.

The sleek body, consisting of a tubular steel frame covered in moulded polyurethane foam with web suspension, forms the basis of all Suita models. It can be fitted with either soft or firmly upholstered seat cushions.

The Suita Sofa comes in three design languages, which differ according to the shape of the seat and back cushions. In addition to the slightly more casual version with pointed cushions and the classic elegant variation, there is also a tufted edition with soft upholstery.



Classic cushions

Firm or soft padding,
available with fabric or leather covers

Pointed cushions

Soft padding,
available with fabric or leather covers

Tufted cushions

Soft padding,
available with fabric covers

CLASSIC CUSHIONS

Elegant shape with large back cushions, linear contours, formal.

POINTED CUSHIONS

Casual, soft shape with inviting comfort, for relaxed seating or reclining.

TUFTED CUSHIONS

The tufted cushions inspire an appreciation of technical sophistication and quality craftsmanship.



Selection of pointed cushions

All Suita elements can be ordered with additional pointed cushions in different sizes, as well as bolsters or head cushions. The table below indicates the standard number and sizes of cushions provided with each furniture model. Additional cushions are separately available.

- **Pointed cushions 40 x 40 cm and 40 x 60 cm:** filled with 100% feathers.
- **Pointed cushions 60 x 60 cm and 60 x 80 cm:** filled with polyurethane foam lozenges and feathers.
- **Bolsters:** filled with polyurethane foam lozenges and feathers.
- **Covers:** removable.



| Pointed cushion sets | 80 x 60 cm | 60 x 60 cm | 60 x 40 cm | 40 x 40 cm | 54 x 16 cm |
|----------------------|------------|------------|------------|------------|------------|
| 2-Seater | 1x | 1x | 1x | 1x | |
| 3-Seater | 1x | 2x | 1x | 1x | |
| Chaise Longue small | | 1x | 1x | | |
| Chaise Longue large | 1x | 1x | 1x | 1x | |
| Daybed | | | | | 1x |



Armrest cushion

An armrest cushion for the Suita Sofa is also optionally available. It comes exclusively in one size and version, and can be added when ordering any Suita Sofa (not standard with any model).

The armrest cushion can be combined with all three sofa variants.

Number of seat and back cushions per sofa element

| | Seat cushion | Back cushion |
|----------------------------|--------------|--------------|
| 2-Seater | | |
| Classic | 1x | 2x |
| Pointed cushions | 1x | 4x |
| Tufted | 1x | 2x |
| 3-Seater | | |
| Classic | 2x | 2x |
| Pointed cushions | 2x | 5x |
| Tufted | 1x | 3x |
| Chaise Longue small | | |
| Classic | 1x | 1x |
| Pointed cushions | 1x | 2x |
| Tufted | 1x | 1x |
| Chaise Longue large | | |
| Classic | 2x | 3x |
| Pointed cushions | 2x | 4x |
| Tufted | 1x | 3x |



3-Seater with classic cushions



3-Seater with pointed cushions



3-Seater with tufted cushions

TUFTED CUSHIONS

One particularity of tufted seat cushions is that they are always exclusively available in a full-length version, i.e. Suita Sofa 3-Seater and Chaise Longue large also have just one full-length seat cushion.

Another characteristic of the 3-seater model with tufting is the number of back cushions – there are three back cushions.

**2-Seater****2-Seater open**

The Suita Sofa comes in two- and three-seat models with closed ends as well as open versions with a single armrest on the left or

right, which can be paired with chaises longues in various lengths.

-
- **Note:** the designations ‚left‘ and ‚right‘ refer to the perspective when viewing the sofa from the front.
-



3-Seater



3-Seater open



Chaise Longue small



Chaise Longue large

The chaise longues of the Suita sofa family by Antonio Citterio are available in the sizes small and large. They can be perfectly combined with the single-armrest Suita sofas but also make a striking solo piece.



Suita Daybed is an elegant lounger with soft upholstery and a classic neck bolster.

- **Daybed:** metal frame with wooden panel, polyurethane foam, soft seat cushion.
- **Covers:** removable.
- **Glides:** non-slip.



The Suita Ottoman is also available in a soft tufted version or a firm non-tufted variant. It is an attractive companion to the sofa, and can be flexibly positioned to take full advantage of the latter's comfort.

- **Ottoman, firm:** wooden panel, polyurethane foam, firm seat cushion.
- **Ottoman, soft and tufted:** wooden panel, polyurethane foam core and chamber cushion overlay (filled with polyurethane foam lozenges, latex and a mix of goose feathers and down).
- **Covers:** removable.
- **Gleiter:** glides for carpet or felt glides for hard floors.



The Suita Club Armchair can be combined with all other members of the Suita sofa family. Thanks to its elegantly understated design, the armchair can also be used on its own or paired with many other sofa models. The Suita Club Armchair is fully upholstered, ensuring excellent comfort even without additional cushions.

- **Body:** moulded polyurethane foam with webbed metal frame.
- **Seat cushion:** polyurethane foam and polyester fibre.
- **Seat height:** 430 mm (applied load 355 mm, measured in accordance with EN 1335-1).
- **Legs:** die-cast aluminium, polished or powder-coated.

Added to a freestanding Suita Sofa, the rear-mounted shelf makes a perfect temporary workspace in combination with a laptop and a chair. Positioned against the wall, the shelf offers a convenient additional surface for storage and display. And a head section fitted to the sofa not only provides extra support, but also helps to block out noise and visual stimuli.

Shelves

Suita 2- and 3-Seater sofas in both closed and open versions can be fitted with a shelf with a linoleum inlay.



The closed version of the Suita 2-Seater and 3-Seater sofas, as well as the Suita Chaise Longue in both sizes, can be fitted with a headrest extension. The head section is available in all cover materials.

The head cushion is available separately and offers enhanced comfort.

- **Head section:** polyurethane moulded foam and metal frame



The structural body of Suita rests on bridge-like legs. Shelf elements and head sections are also attached to the legs. The Suita Sofa has a comfortable seat height of 25 cm. The aluminium legs and frame have a polished finish or are alternatively powder-coated in soft light, chestnut or basic dark.



Polished aluminium

Suita configuration featuring 2-Seater sofa with open end, Chaise Longue large with head section and ottoman, Linho cover fabric (01 pearl), frame and legs in polished aluminium. Shelf in soft light with linoleum inlay (01 pebble).



Powder-coated in soft light

Suita configuration featuring 2-Seater sofa with open end, Chaise Longue large with head section and ottoman, Linho cover fabric (05 rose quartz), frame and legs in powder-coated aluminium (69 chestnut). Shelf powder-coated (69 chestnut) with linoleum inlay (03 peat).



Powder-coated in basic dark

Suita configuration featuring 2-Seater sofa with open end, Chaise Longue large with head section and ottoman, Linho cover fabric (07 olive), frame and legs in powder-coated aluminium with basic dark finish. Shelf in basic dark with linoleum inlay (02 charcoal).

52
soft light
powder-coated
(smooth)

03
aluminium
polished

69
chestnut
powder-coated
(smooth)

30
basic dark
powder-coated
(smooth)

Base

01
pebble

03
peat

02
charcoal

tray-inlay

Corsaro Home, F40

vitra.

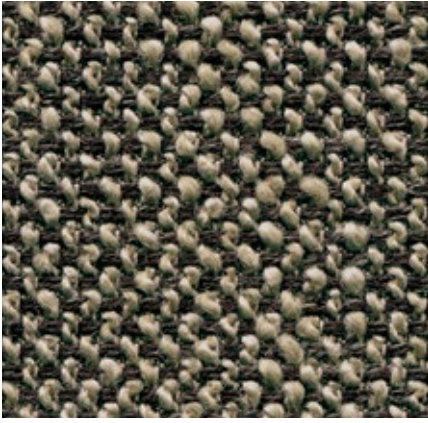

Corsaro is a sophisticated combination of fine and coarse yarns that give the fabric a natural look with a Mediterranean flair. The two-tone and three-tone shades interwoven with several novelty yarns add particular vibrancy to large surface areas.

Corsaro is available in 13 colours.

| | |
|---------------------|---|
| Material | 5% polyamide, 10% cotton, 46% acrylics, 5% linen, 20% wool, 14% polyester |
| Weight | 450 g/m ² (13.3 oz/y ²) |
| Width | 140 cm +/- 2 cm (55") |
| Abrasion resistance | 35,000 Martindale |
| Fastness to light | Type 5 |
| Pilling | Grade 3-4 |
| Fastness to rubbing | Grade 3-4 dry and wet |



Cosy 2 Home/Office, F80



Cosy 2 is a high-quality milled woolen cloth with a warm character. The lively melange yarn emphasises the fabric's natural colours – from delicate shades to vibrant hues – and gains added elegance with colour-coordinated stitching. The fabric offers thermal comfort and excellent durability, making it suited for upholstered furniture in office settings as well as residential applications.

Cosy 2 is available in 15 colours.

| | |
|---------------------|--|
| Material | 20% polyamide, 80% new wool |
| Weight | 590 g/m ² (17.4 oz/y ²) |
| Width | 154 cm +/- 2 cm (60") |
| Abrasion resistance | 50,000 Martindale |
| Fastness to light | Type 6 |
| Pilling | Grade 4-5 |
| Fastness to rubbing | Grade 4-5 dry and wet |



Credo Home/Office, F120

vitra.

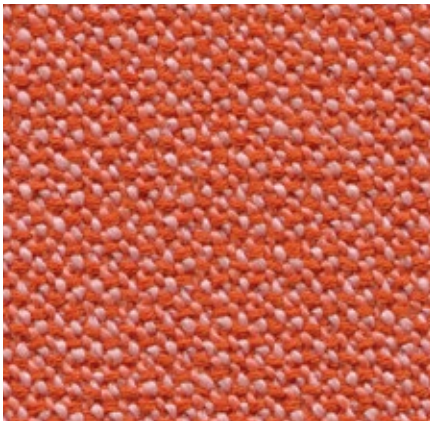

Credo is a durable woollen fabric made of premium worsted yarn with a pleasant feel. The two- and three-tone colours give this fabric a characteristic structure and vibrant appearance. Credo allows for an effective exchange of heat to ensure comfortable thermal conditions for the sitter. The fabric can also be used in office environments.

Credo is available in 22 colours.

| | |
|---------------------|--|
| Material | 80% cotton, 20% polyester |
| Weight | 640 g/m ² (18.9 oz/y ²) |
| Width | 145 cm +/- 2 cm (57") |
| Abrasion resistance | 100,000 Martindale |
| Fastness to light | Type 6 |
| Pilling | Grade 4 |
| Fastness to rubbing | Grade 4-5 dry and wet |



Dumet Home, F80



Dumet is a cotton blend in a plain weave with a lively appearance. The natural mixed tones create an elegant look with an Italian flair. Dumet is soft and cool to the touch.

Dumet is available in 20 colours.

| | |
|---------------------|--|
| Material | 9% polyamide, 46% cotton, 8% linen, 22% wool, 15% rayon |
| Weight | 485 g/m ² (14.3 oz/y ²) |
| Width | 147 cm +/- 2 cm (57") |
| Abrasion resistance | 40,000 Martindale |
| Fastness to light | Type 5 |
| Pilling | Grade 3-4 |
| Fastness to rubbing | Grade 3-4 dry and wet |



Iroko 2 Home, F8o

vitra.



Iroko 2 is a soft, flat woven fabric made with chenille yarn. The piles in the yarn give the weave a lively surface texture with an inviting, velvety touch. The fabric's cotton fibres provide excellent cooling properties.

Iroko 2 is available in 17 colours.

| | |
|---------------------|--|
| Material | 32% cotton, 48% acrylics, 20% polyester |
| Weight | 700 g/m ² (20.6 oz/y ²) |
| Width | 152 cm +/- 3 cm (60") |
| Abrasion resistance | 40,000 Martindale |
| Fastness to light | Type 5 |
| Pilling | Grade 3-4 |
| Fastness to rubbing | Grade 3-4 dry and wet |



Laser Home/Office, F4o

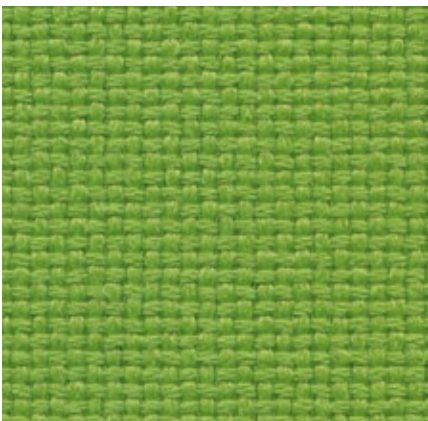

With its distinctive woven structure, Laser makes a robust and striking cover fabric. The varied palette offers a wide selection of colours, with the duotones showing off the woven structure to even greater advantage. Practical and easy to care for, as well as durable and highly abrasion-resistant, Laser is also well suited for office environments.

Laser is available in 35 colours.

| | |
|---------------------|--|
| Material | 100% polyester Trevira CS |
| Weight | 520 g/m ² (15.3 oz/y ²) |
| Width | 145 cm +/- 2 cm (57") |
| Abrasion resistance | 40,000 Martindale |
| Fastness to light | Type 6 |
| Pilling | Grade 4-5 |
| Fastness to rubbing | Grade 4-5 dry and wet |



Linho Home, F80

vitra.



The high-quality linen fabric Linho is manufactured in Belgium, from the plant to the finished textile. It has the slightly irregular appearance that is typical of linen yarn. Due to its high percentage of linen, Linho tends to form elegant creases, lending a natural look to soft upholstered furniture.

Linho is available in 10 colours.

| | |
|---------------------|--|
| Material | 9% polyamide, 91% linen |
| Weight | 450 g/m ² (13.3 oz/y ²) |
| Width | 137 cm +/- 2 cm (54") |
| Abrasion resistance | 18,000 Martindale |
| Fastness to light | Type 5 |
| Pilling | Grade 3 |
| Fastness to rubbing | Grade 3 dry and wet |



Mello Home, F40



Mello is an elegant cotton fabric with a pleasant softness and cool tactile qualities. Thanks to a thicker melange yarn of recycled cotton, the robust twill weave has a lively yet balanced appearance. The understated colour palette for Mello ranges from pastel tones to natural, earthy shades and darker hues.

Mello is available in 12 colours.

| | |
|---------------------|--|
| Material | 80% cotton, 20% polyester |
| Weight | 530 g/m ² (15.6 oz/y ²) |
| Width | 142 cm +/- 2 cm (56") |
| Abrasion resistance | 30,000 Martindale |
| Fastness to light | Type 5 |
| Pilling | Grade 4 |
| Fastness to rubbing | Grade 3-4 dry and wet |

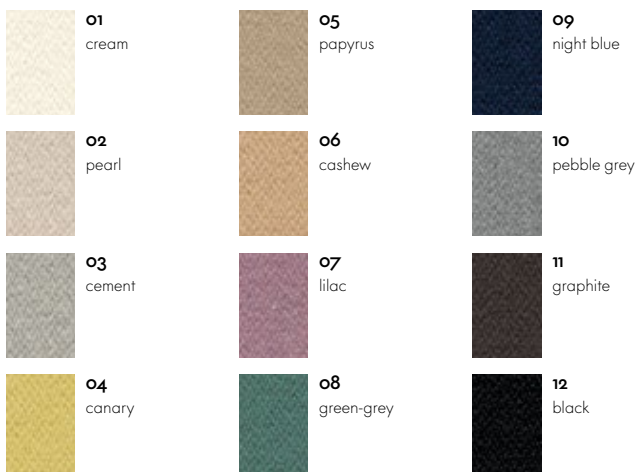

Olimpo Home, F60



The typical linen texture of Olimpo gives the fabric a very fine and natural overall appearance. The fabric's high percentage of linen, clearly evident to the touch, results in comfortably cool conditions for the sitter. Thanks to the combination of viscose and linen, the fabric is durable and abrasion-resistant and exhibits a fine sheen.

Olimpo is available in 10 colours.

| | |
|---------------------|--|
| Material | 70% linen, 30% rayon |
| Weight | 520 g/m ² (15.3 oz/y ²) |
| Width | 146 cm +/- 3 cm (57") |
| Abrasion resistance | 30,000 Martindale |
| Fastness to light | Type 5 |
| Pilling | Grade 3-4 |
| Fastness to rubbing | Grade 3-4 dry and wet |



Reed Home, F100



The elegant finely patterned fabric Reed is a blend of linen, wool and cotton. The structure of the fabric designed by Hella Jongerius has a hand-made look, its irregular lively linen yarn lending the fabric a natural expression. Reed is cool and soft to the touch and can be perfectly combined with other fabrics and materials. Reed is available in 19 colours.

| | |
|---------------------|--|
| Material | 7% polyamide, 48% cotton, 25% new wool, 20% linen |
| Weight | 400 g/m ² (11.8 oz/y ²) |
| Width | 142 cm +/- 2 cm (56") |
| Abrasion resistance | 50,000 Martindale |
| Fastness to light | Type 5 |
| Pilling | Grade 3-4 |
| Fastness to rubbing | Grade 3-4 dry and wet |



Volo Home/Office, F60

vitra.



Volo is a finely structured wool blend with a refined weave that gives it an elegant appearance. This expressive textile shows strong solid colours to full advantage while simultaneously offering pleasant tactile qualities. With its soft look and appealing texture, Volo is a perfect fit for home interiors, but it is also well suited for use in the contract sector.

Volo is available in 17 colours.

| | |
|---------------------|--|
| Material | 15% polyamide, 85% new wool |
| Weight | 435 g/m ² (12.8 oz/y ²) |
| Width | 145 cm +/- 3 cm (57") |
| Abrasion resistance | 100,000 Martindale |
| Fastness to light | Type 6 |
| Pilling | Grade 4-5 |
| Fastness to rubbing | Grade 4-5 dry and wet |



Leather Home/Office, L20



The standard grade leather used by Vitra is a robust cowhide leather, dyed-through, pigmented and embossed with an even grain pattern. Since it is hard-wearing and easy to maintain, it can also be used in office environments.

Leather is available in 16 colours.

| | |
|---------------------|---|
| Material | Robust cowhide with a distinctive, even grain |
| Fastness to light | Type 6 |
| Thickness | 1.1–1.3 mm |
| Fastness to rubbing | Grade 4 dry and wet |

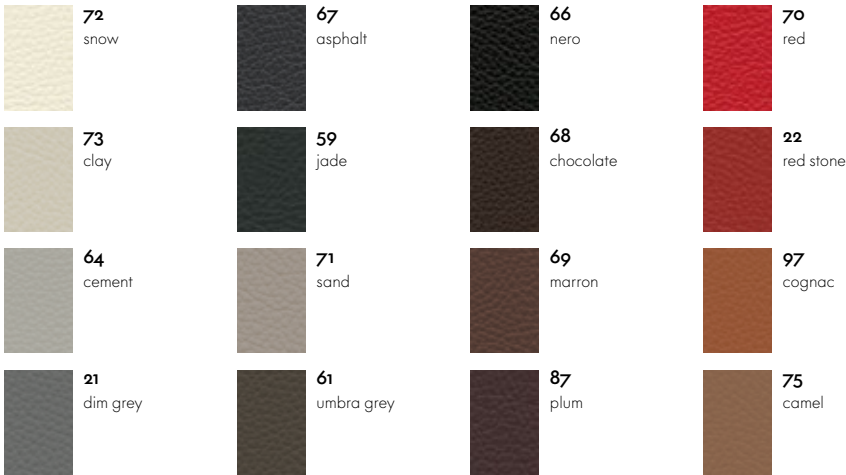

Leather Natural Home, L60

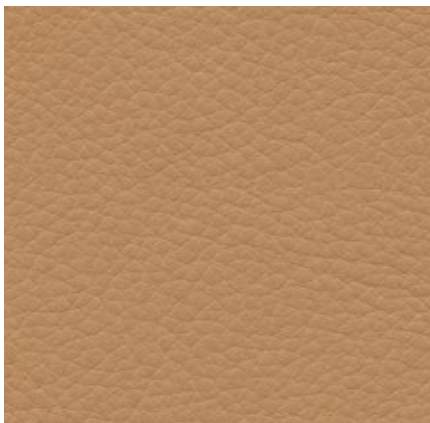

Leather Natural is a very soft cowhide leather; the untreated grain gives it a very natural appearance. It is porous, breathable and warm to the touch. Through use, it takes on a lively, characteristic patina. It is available in 4 colours.

| | |
|-------------------|--|
| Material | Aniline cowhide nappa leather with an open-pored texture and natural grain |
| Fastness to light | Type 3 |
| Thickness | 1.3–1.5 mm |

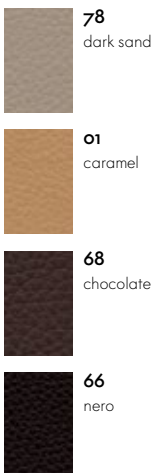

Leather Premium Home/Office, L40

vitra.



Leather Premium is a relatively smooth cowhide leather with a flat grain and fine top sheen. It is dyed-through and lightly pigmented. The semi-aniline leather is soft to the touch, like a leather glove. Leather Premium is available in 22 colours.

Material

Semi-aniline nappa leather with a very soft and supple feel

Fastness to light

Type 5

Thickness

1.1-1.3 mm

Fastness to rubbing

Grade 4 dry and wet

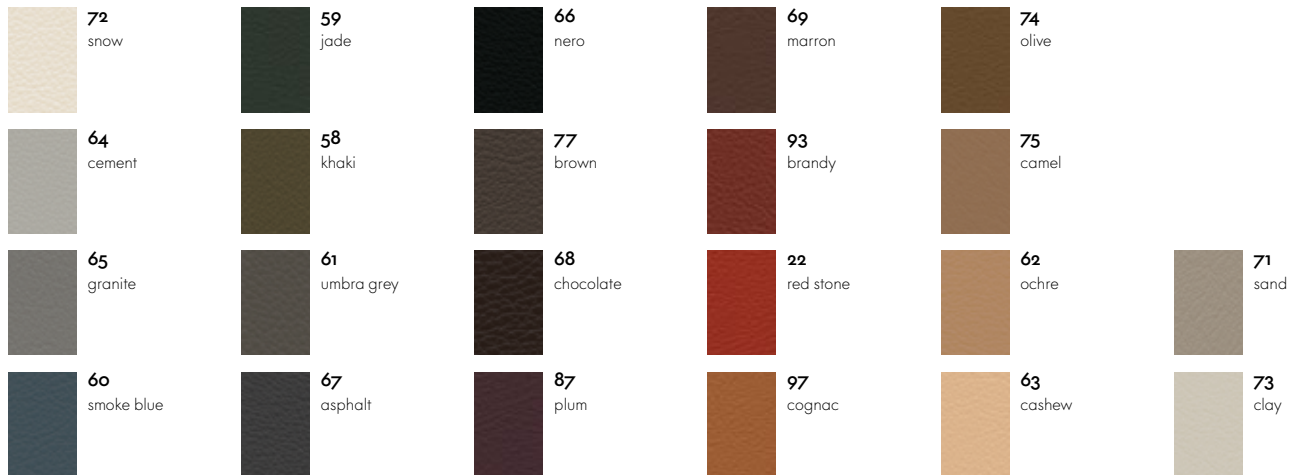

Vitra has over fifty years of experience in the production of upholstered furniture. Premium materials, skilled craftsmanship and high quality standards at Vitra are a guarantee for long-lasting products. In Vitra's own test centre, our upholstered furnishings are regularly subjected to a wide range of tests that far exceed common standards.

Care instructions:

Exposure to direct sunlight should be avoided whenever possible, since intensive radiation can cause cover materials to fade.

To retain the original fullness and shape of your sofa, cushions should be regularly shaken and plumped.

Folds and creases from sitting can be prevented in all types of upholstery by smoothing the cover material after use.

USEFUL FACTS ABOUT COVER MATERIALS

Covers have a decisive influence on the appearance and characteristics of upholstered furniture. Along with the type of material, weave and aesthetic features of the textile, a major role is played by technical properties such as resistance to abrasion, fading or stains.

Function and performance are primarily determined by the type of fabric used. In general, synthetic fibres are superior to natural fibres in terms of their technical characteristics. For this reason, blends of different materials are employed to combine the advantages of the individual fibres.

In the following, you will find some of the key features of the textiles used by Vitra in its upholstery covers:

Cotton (CO)

Skin-friendly natural fibre of plant origin, comfortable to the touch, readily absorbs moisture. Often inferior to synthetic fibres with regard to colourfastness and light resistance, flat weaves susceptible to pilling.

Linen (LI)

Natural fibre of plant origin with slight lustre, cool and comfortable, repels dirt, no pilling. Limited colourfastness to light and crocking, creases easily.

Wool (WO)

Elastic natural fibre of animal origin, naturally self-cleaning – a brief airing disperses absorbed odours, leaving the wool smelling neutral and fresh again. Good resistance to light and abrasion, highly absorbent, minimal creasing, low flammability. Subject to pilling and matting.

Polyester (PE), Polyacrylic (PA), Viscose (VI)

Synthetic, highly uniform, lightfast fibres. The non-absorbent properties of synthetics can be mitigated with fibre blends and weaving techniques.

The overall look of a piece of furniture is influenced by the colour and type of cover fabric, its properties (elastic or non-stretch) as well as the upholstery technique (removable or attached covers). Consequently, a sofa can take on a different appearance depending on the cover material. Generally speaking, cover fabrics with some elasticity are less susceptible to creases and puckering, since they have an adaptable fit on three-dimensional forms. Heavier cover materials such as Over, Laser or Credo drape more smoothly while thinner materials exhibit a finer rippling effect.

Care instructions:

All Suita covers are removable. Fabric covers can be taken to a professional cleaner. Prior to treatment, please be sure to note the composition of the cover fabric and follow care instructions.

Should you ever need to replace individual parts or covers due to wear and tear, please contact your local Vitra retailer.

The products developed by Vitra in collaboration with internationally renowned designers are distinguished by excellent quality and great longevity. Based on the criteria of durability, warmth and comfort, high-quality leather is superior to almost any other material.

Leather is a robust natural product with an individual character that lends a timeless elegance to furnishings.

The quality of leather depends, in part, on the animals themselves: their breed, age and gender, their geographical origins and respective climate conditions. Vitra exclusively uses leather sourced from animals in Scandinavia and Central Europe. Scars, sting marks and scratches are normal characteristics of leather that highlight its natural appearance. Vitra utilises only the best hides.

Another factor that influences the quality of leather is the tanning of the skins. Tanning is the name of the process used to turn cowhide into leather. The art of tanning requires the same skill and attention to detail as it has for centuries: before the selected salt-cured skins are ready for tanning, they must be soaked in water and the hair must be removed. The valuable outer skin is fleshed and cleaned before the actual tanning process begins. The skins are soaked in large, rotating vats filled with tanning agents obtained from plants, minerals or synthetic compounds, which are absorbed by the fibres to make the leather soft and durable.

Vitra uses leather in three different qualities:

Pigmented leather (Leather)

Leather in standard quality is pigmented. It is especially robust and offers outstanding economical value. Highly resistant to both UV radiation and abrasion, its appearance and physical properties change very little over a long period of time. The top side of the skin is sanded, pigmented with an opaque surface colour and embossed with an even grain pattern. Pigmented leather is simple to care for and also easy to clean.

Semi-aniline leather (Leather Premium / Leather Grand)

Vitra's Premium and Grand leathers are both semi-aniline leathers mainly distinguished by differences in their grain textures. Premium leather has a silky, smooth-grained surface, while the grain pattern of Grand leather is more pronounced. This is achieved in a milling process which makes the skin more pliable and gives added volume to the grain. Semi-aniline leather is dyed through with a lightly pigmented finishing layer. Premium and Grand leathers are a good choice for connoisseurs who value durability but also desire the soft, warm feel of natural leather. The beauty of this leather evolves with use, so that the upholstery acquires its typical patina as the years go by.

Aniline leather (Leather Natural)

Vitra's Natural leather is a pure aniline leather. It is dyed without a pigmented surface coating, making it less resistant to light but fully retaining its natural appearance. Only a minimal protective surface finish is applied. The natural processing of aniline leather gives it maximum breathability and a silky, soft feel. Careful treatment preserves the beauty of this exquisite cover material and lends it an appealing, individual patina.

Care instructions:

Furniture with leather upholstery should not be positioned in close proximity to heat sources, which can cause leather to dry out and become brittle. We also recommend that leather upholstery be protected from permanent exposure to direct sunlight, since intensive radiation can diminish the quality of leather and cause it to fade over time.

For occasional cleaning, add flakes of a hard neutral soap to distilled water and stir until frothy. Moisten a soft cloth (do not use microfibre cloth) and wipe gently over the leather surface, leaving it slightly damp. The ingredients in the soapy liquid remove dust and dirt, while also supplying the leather with needed conditioners.

Liquid spills should be immediately dabbed dry and wiped off with a little water (do not use microfibre cloth).

Small soiled spots can be removed with a colourless rubber (eraser).

Once a year, the leather should be treated with a special leather care product; never use aggressive cleaning agents. Please refer to the leather care instructions provided with your sofa.

Additional information on leather care can be found at: www.lck-international.com.

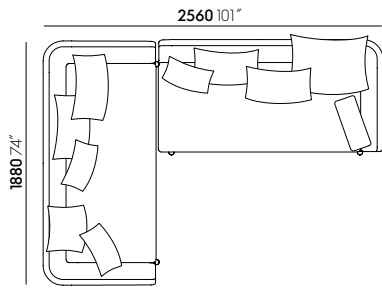

Suita Sofa 2-Seater, Suita Sofa 2-Seater open

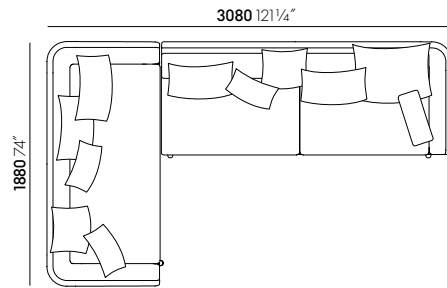

Suita Sofa 2-Seater, Suita Sofa 3-Seater open

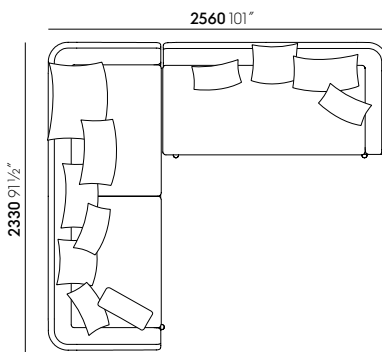

Suita Sofa 3-Seater, Suita Sofa 2-Seater open

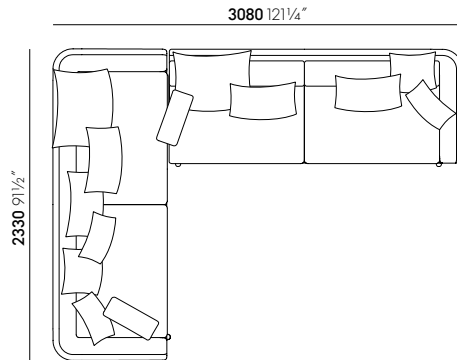

Suita Sofa 3-Seater, Suita Sofa 3-Seater open

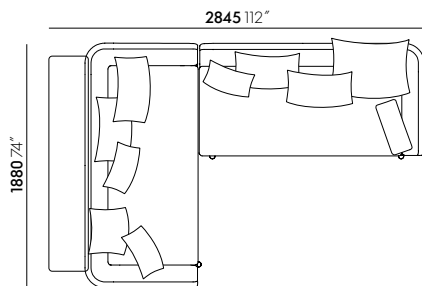

Suita Sofa 2-Seater with shelf, Suita Sofa 2-Seater open

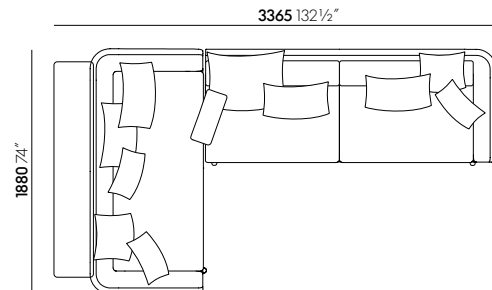

Suita Sofa 2-Seater with shelf, Suita Sofa 3-Seater open

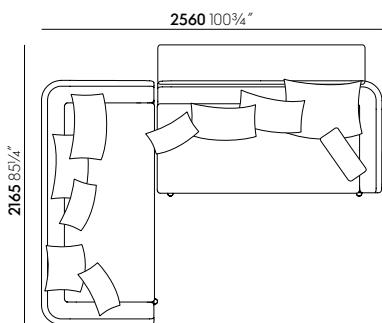

Suita Sofa 2-Seater, Suita Sofa 2-Seater open with shelf

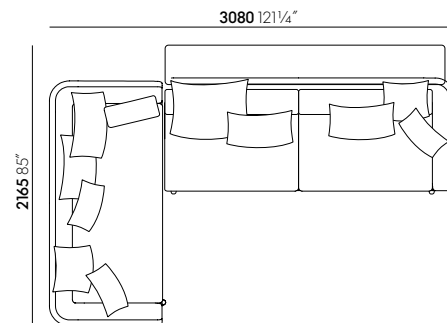

Suita Sofa 2-Seater, Suita Sofa 3-Seater open with shelf

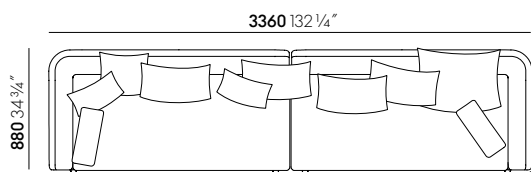

Suita Sofa 2-Seater open right, Suita Sofa 2-Seater open left



Suita Sofa 2-Seater open right, Suita Sofa 3-Seater open left

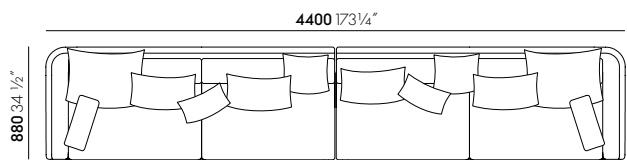

Suita Sofa 3-Seater open right, Suita Sofa 3-Seater open left

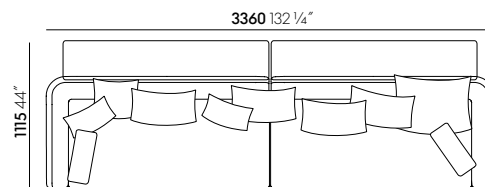

Suita Sofa 2-Seater open right, Suita Sofa 2-Seater open left, both with shelf

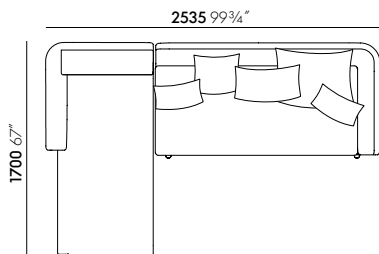

Suita Chaise Longue small, Suita Sofa 2-Seater open

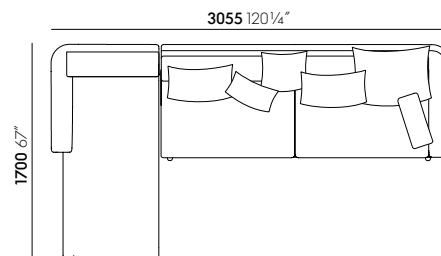

Suita Chaise Longue small, Suita Sofa 3-Seater open

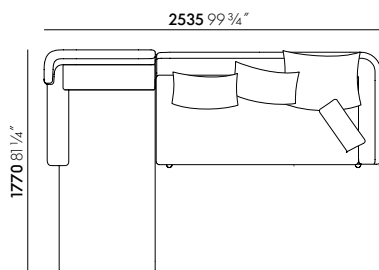

Suita Chaise Longue small with head section, Suita Sofa 2-Seater open

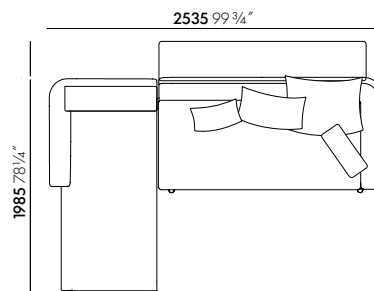

Suita Chaise Longue small, Suita Sofa 2-Seater open with shelf

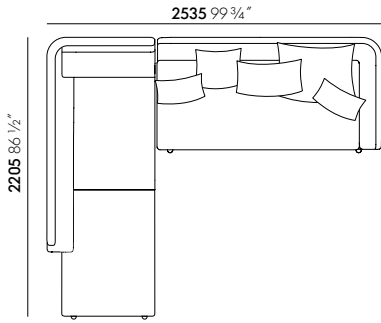

Suita Chaise Longue large, Suita Sofa 2-Seater open

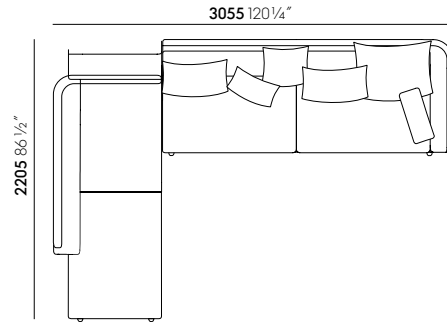

Suita Chaise Longue large, Suita Sofa 3-Seater open

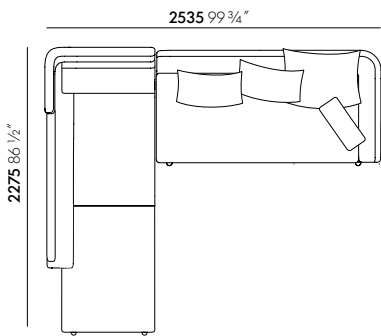

Suita Chaise Longue large with head section, Suita Sofa 2-Seater open

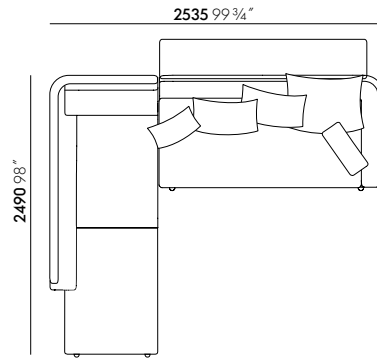

Suita Chaise Longue large, Suita Sofa 2-Seater open with shelf

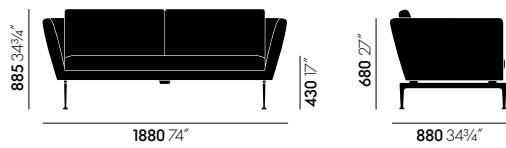

Suita Sofa 2-Seater

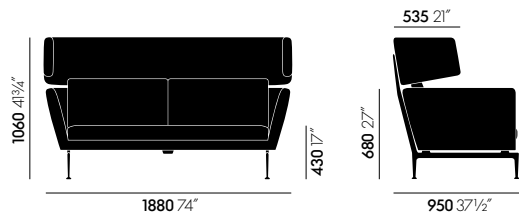

Suita Sofa 2-Seater with head section

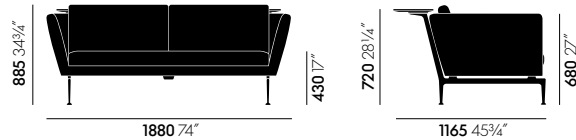

Suita Sofa 2-Seater with shelf

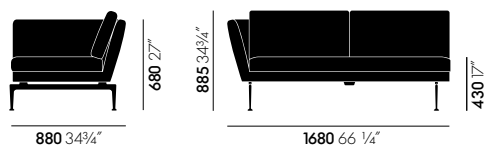

Suita Sofa 2-Seater, open, armrest left

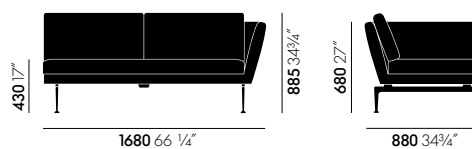

Suita Sofa 2-Seater, open, armrest right

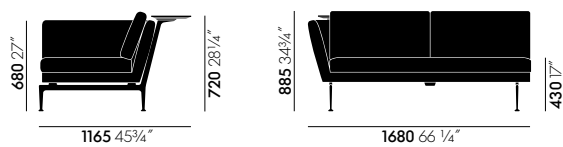

Suita Sofa 2-Seater, open, armrest left, with shelf

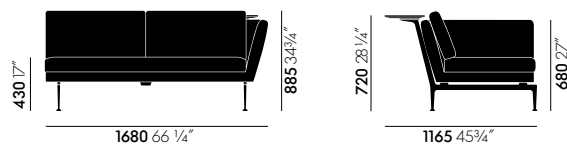

Suita Sofa 2-Seater, open, armrest right, with shelf

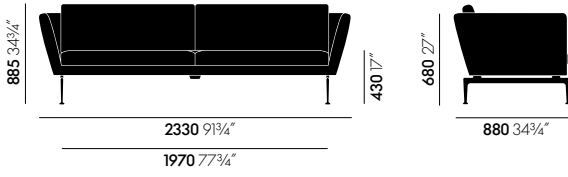

Suita Sofa 3-Seater

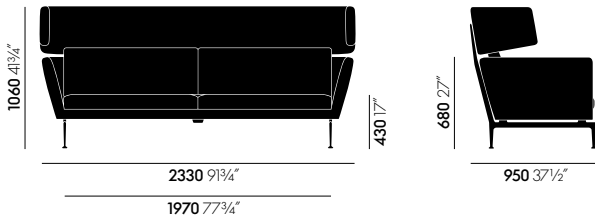

Suita Sofa 3-Seater with head section

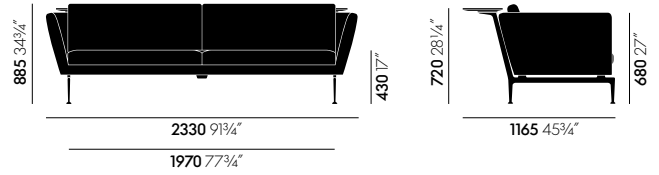

Suita Sofa 3-Seater with shelf

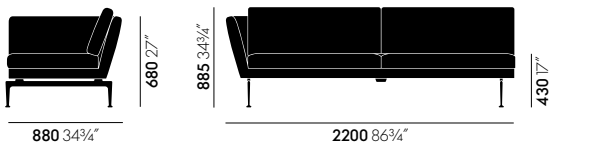

Suita Sofa 3-Seater, open, armrest left

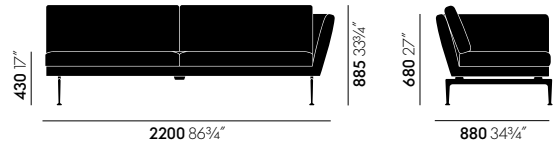

Suita Sofa 3-Seater, open, armrest right

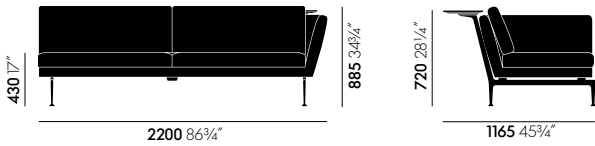

Suita Sofa 3-Seater, open, armrest right, with shelf

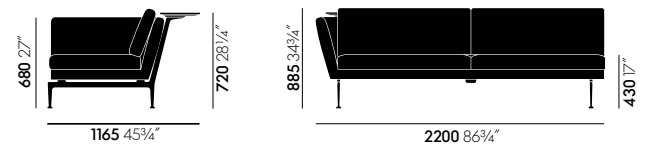

Suita Sofa 3-Seater, open, armrest left, with shelf

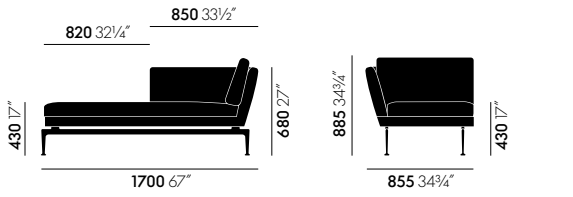

Suita Chaise Longue small, left

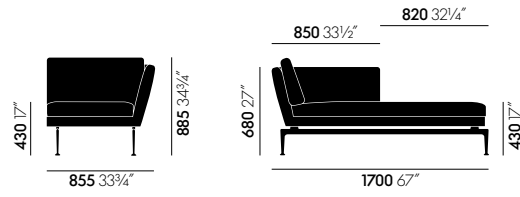

Suita Chaise Longue small, right

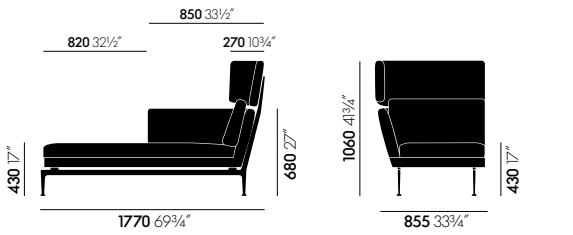

Suita Chaise Longue small, left, with head section

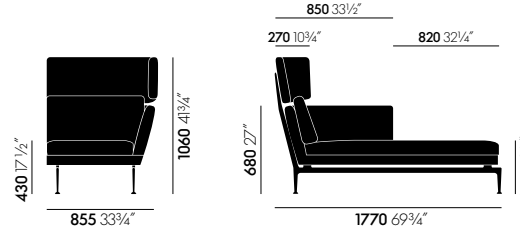

Suita Chaise Longue small, right, with head section

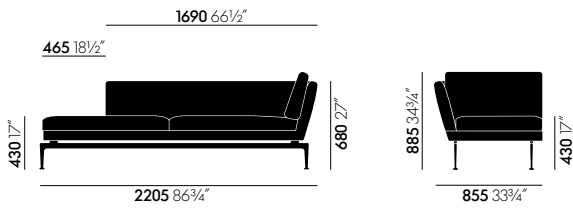

Suita Chaise Longue large, left

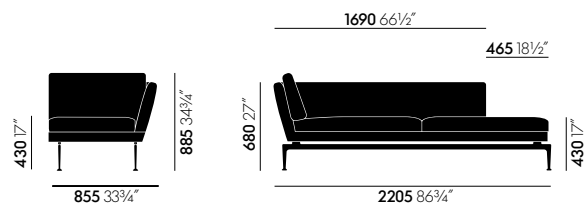

Suita Chaise Longue large, right

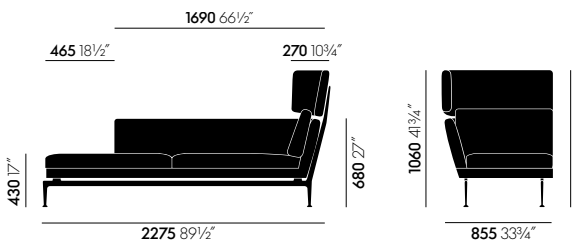

Suita Chaise Longue large, left, with head section

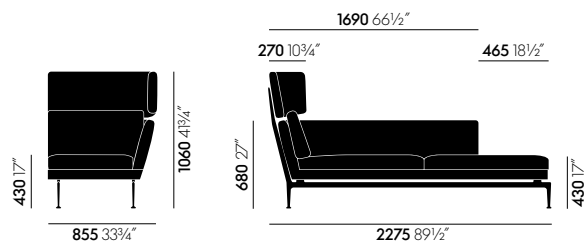

Suita Chaise Longue large, right, with head section



Suita Daybed

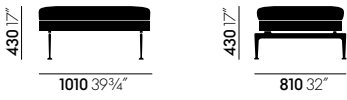

Suita Ottoman

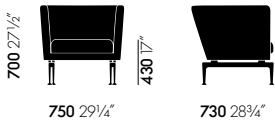

Club Armchair

