

## Classic



The Classic collection furnishes the office space with high-backed executive seating, managerial and meeting seating with fixed feet and stools, featuring an understated design and luxury covers, with a choice of eight catalogue finishes, fabric and leather, in numerous colour versions. The frame, in chromed steel or matte black coated, also has a base with five spokes available in matte black aluminium and gloss aluminium finishes.

### Projects

**Coca Cola**, Kiev, Ukraine (2011)

**Credo**, Tel Aviv, Israel (2010)

**Crédit Lyonnais**, Villejuif, France (2011)

**Paroc**, Vilnius, Lithuania (2012)

**NRS Media**, Londra, United Kingdom (2012)

**PTC**, Dublino, Ireland (2017)

**Epsilon**, Parigi, France (2017)

## Manager

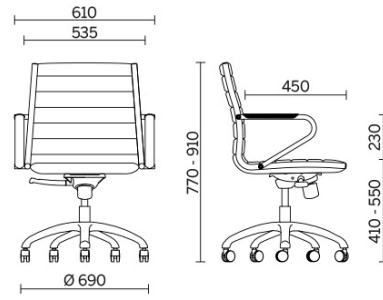

## Materials and colours

### Upholstery



Leather S + Faux leather N  
Available colours 13

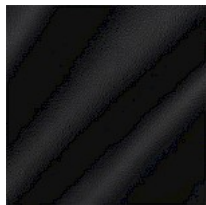

Leather TS  
Available colours 13

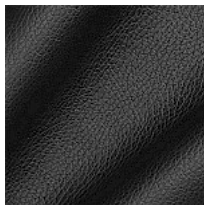

Faux leather N  
Available colours 13

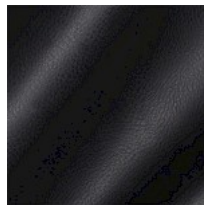

Faux leather CX  
Available colours 13

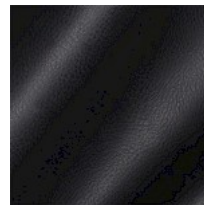

Faux leather CI  
Available colours 13

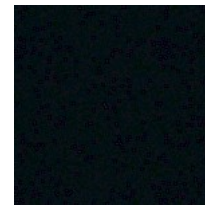

Fabric SY | Sinergy  
Available colours 11



Fabric ME  
Available colours 13

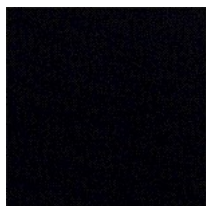

Fabric IP  
Available colours 13

**Questo prodotto è garantito 5 anni.** Sitland Spa si riserva di apportare modifiche e/o migliorie di carattere tecnico ed estetico ai propri modelli e prodotti in qualsiasi momento e senza preavviso. Le foto e i colori visualizzati sono puramente indicativi e possono variare rispetto alla realtà. Per maggiori informazioni si prega di contattare il nostro Servizio Clienti [service@sitland.com](mailto:service@sitland.com)