

1 ▶

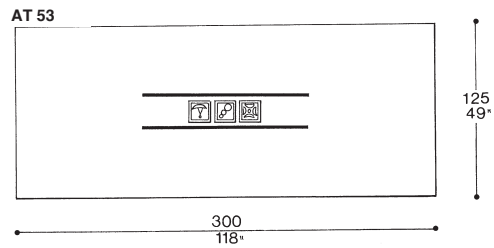

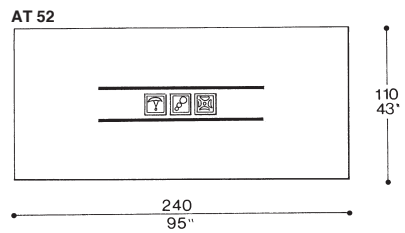

2 ▶

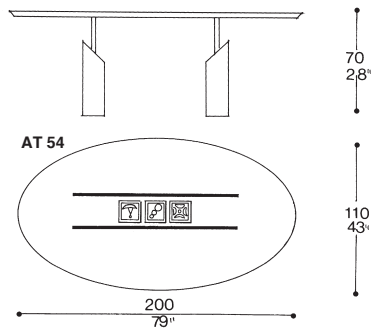
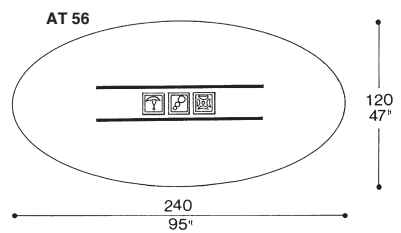
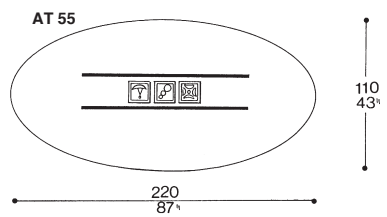

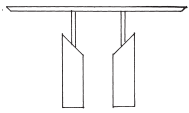

AT 57

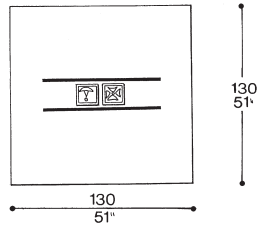

AT 58

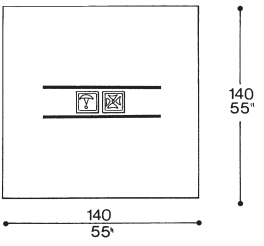

3 ▶

AT 59

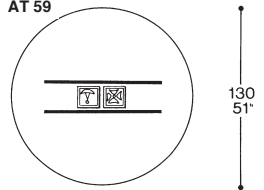

AT 60

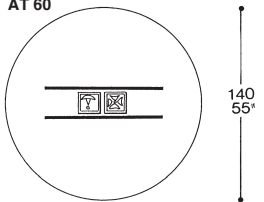

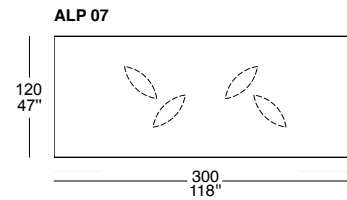
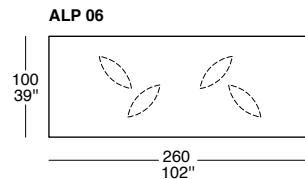
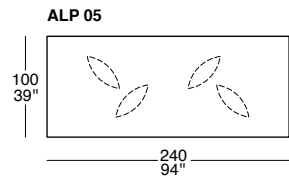
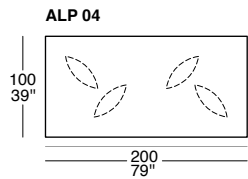
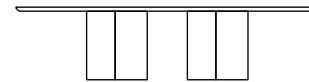
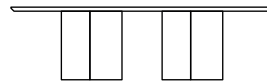
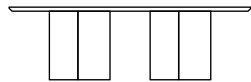
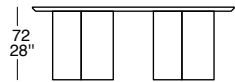
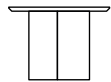
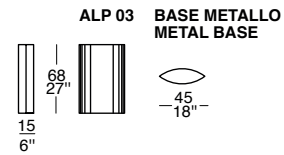
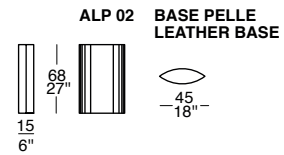
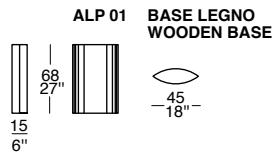

4 ►

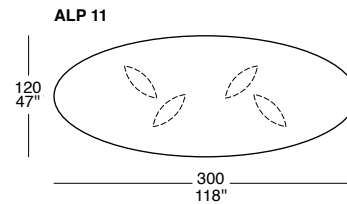
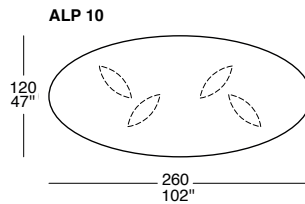
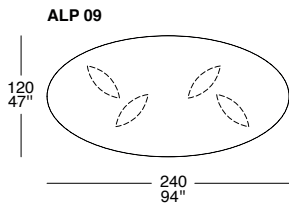
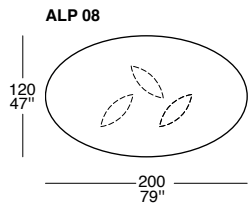

N.B. Il prezzo del tavolo è composto dal prezzo del piano più il prezzo delle basi.
The price of the dining table is composed from the price of the top and the price of the bases.

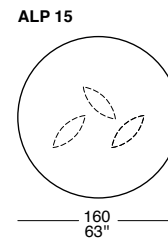
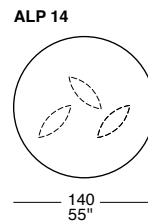
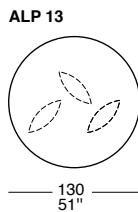
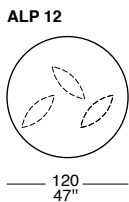
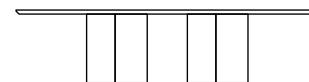
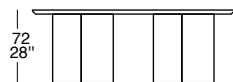
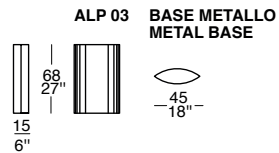
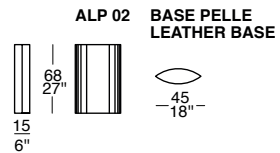
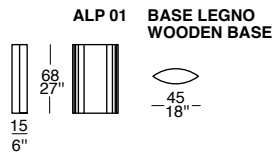

5 ►

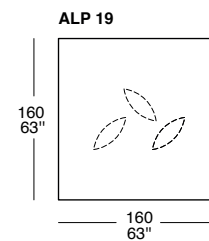
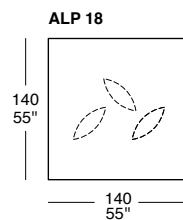
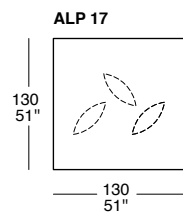
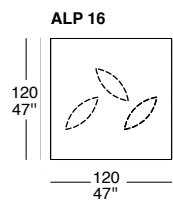

N.B. Il prezzo del tavolo è composto dal prezzo del piano più il prezzo delle basi.
The price of the dining table is composed from the price of the top and the price of the bases.

DILL/GRANIPLIA

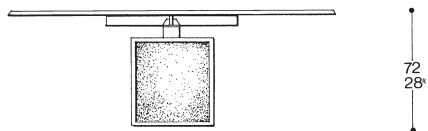

DILL/ART



DILL/GRAFFITI

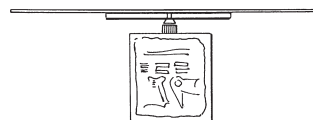

DL 01

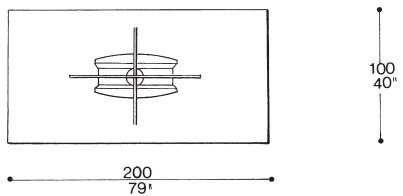

DL 02

DL 56

6 ▶

DL 22

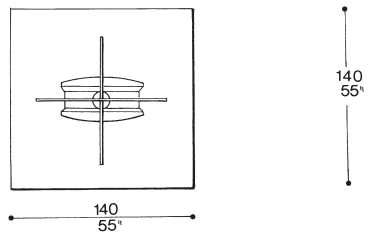

DL 23

DL 63

DL 19

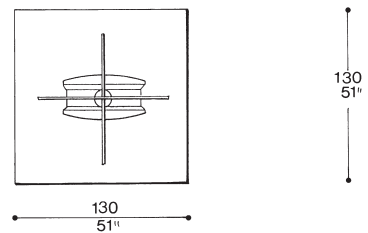

DL 20

DL 62

DILL/GRANIGLIA

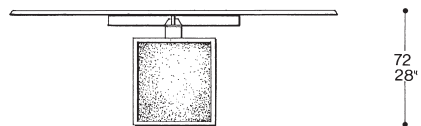

DL 16

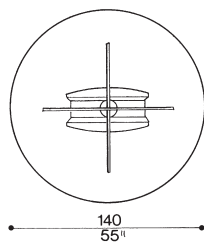

DILL/ART

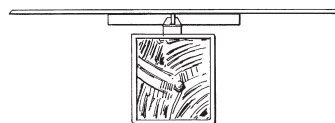

DL 17

DILL/GRAFFITI

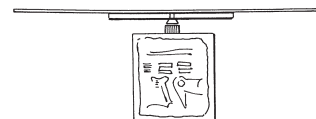

DL 61

7 ▶

DL 13

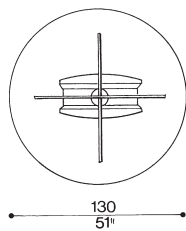

DL 14

DL 60

DL 10

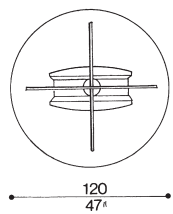

DL 11

DL 59

DILL/GRANIGLIA

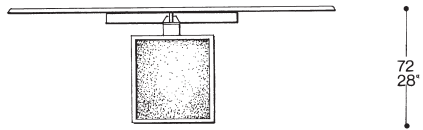

DILL/ART

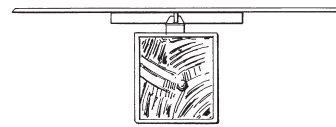

DILL/GRAFFITI

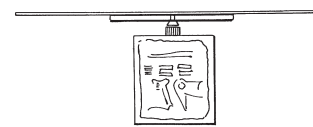

DL 07

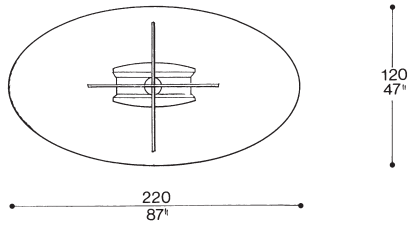

DL 08

DL 58

8 ▶

DL 04

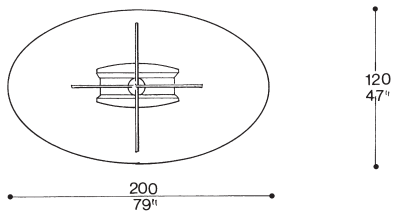

DL 05

DL 57

DL 43

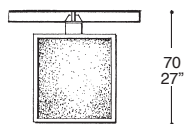

DL 44



DL 64

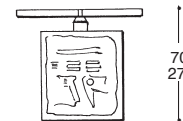

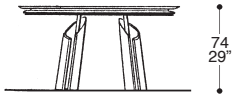

OY 39

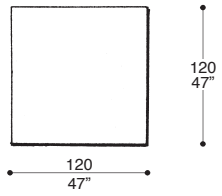

OY 40

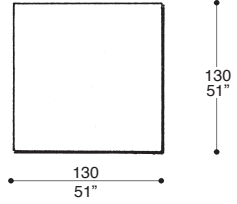

OY 41

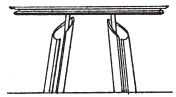
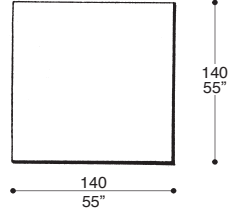

9 ▶

OY 36

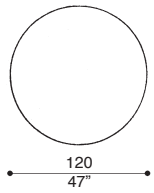

OY 37

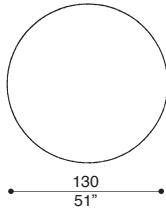

OY 38

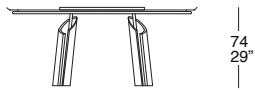
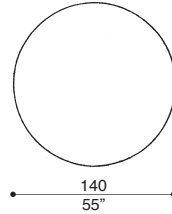

OY46

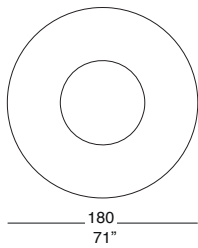

OY47

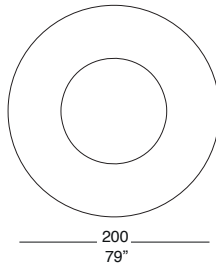

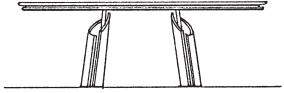

74
29"

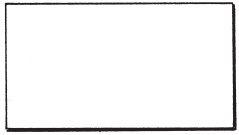

110
43"

OY 30

200
79"

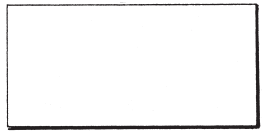

110
43"

OY 31

220
86"

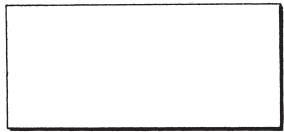

110
43"

OY 32

240
94"

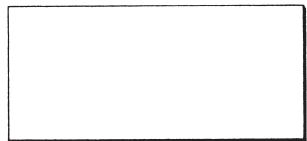

120
47"

OY 42

260
102"

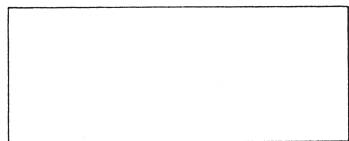

120
47"

OY 43

300
118"

10 ►

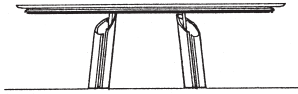

74
29"

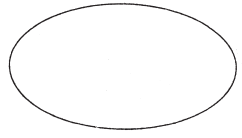

110
43"

200
79"

OY 33

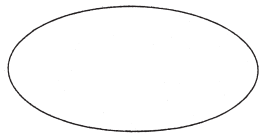

110
43"

220
86"

OY 34

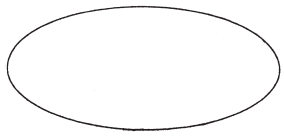

110
43"

240
94"

OY 35

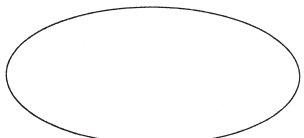

120
47"

260
102"

OY 44

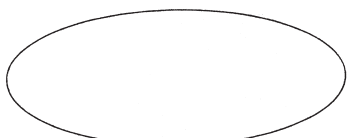

120
47"

300
118"

OY 45

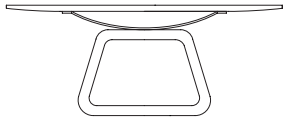

72
28"

ROG 01



100
39"

200
79"

ROG 02



100
39"

240
94"

12 ►

ROG 03



100
39"

260
102"

ROG 04



100
39"

300
118"

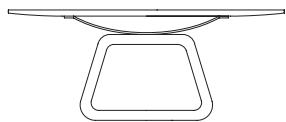

72
28"

ROG 05

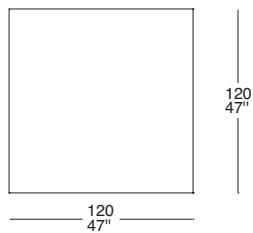

ROG 06

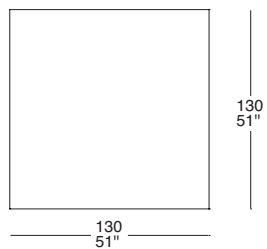

ROG 07

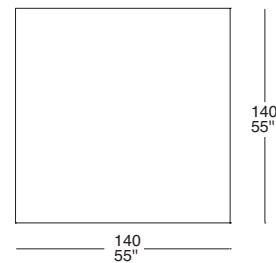

ROG 08

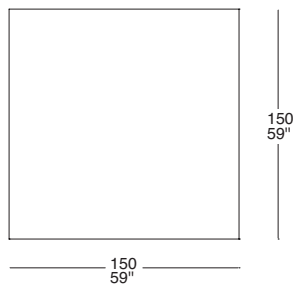

ROG 09

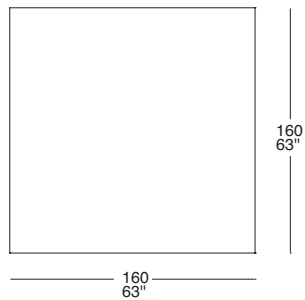

ROG 10

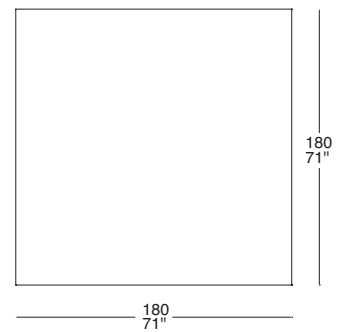

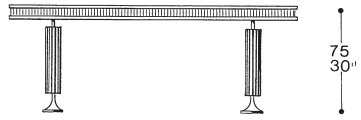

RU 01

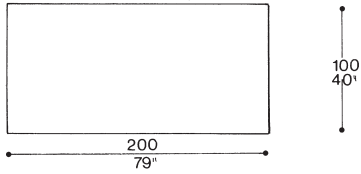

RU 10

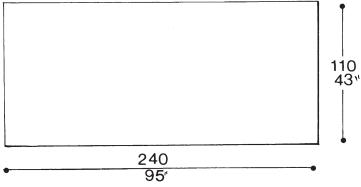

14 ▶

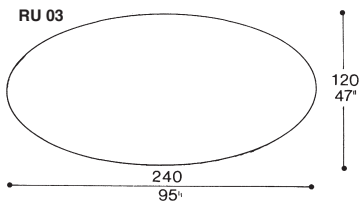
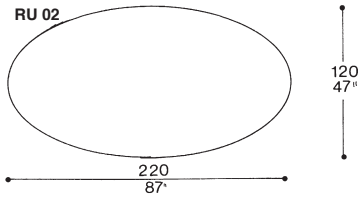

RU 04

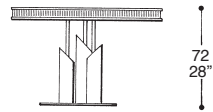
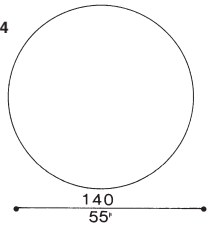

RU 12

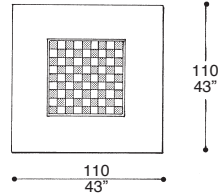

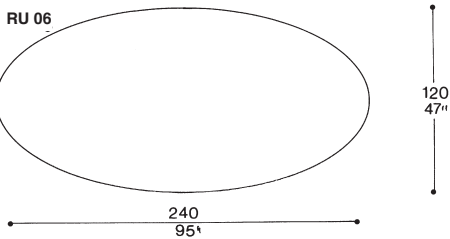
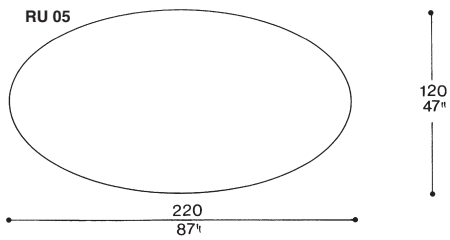
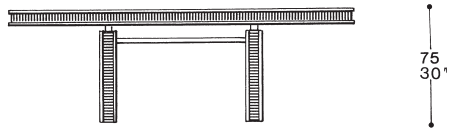

15 ▶

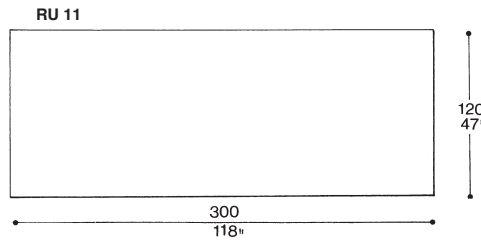
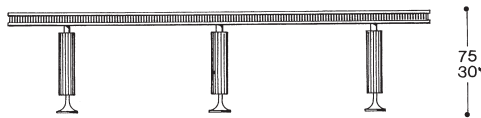

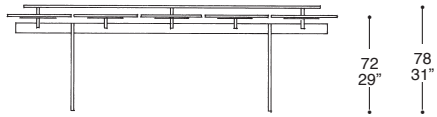

SQ 02

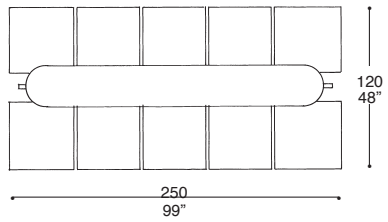

SQ 01

16 ▶

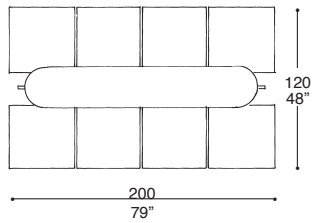

SQ 03

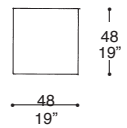



VAN 01

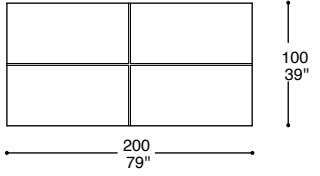

VAN 02

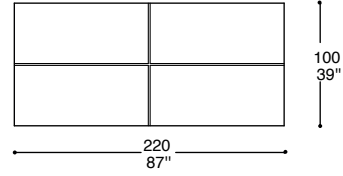

VAN 03

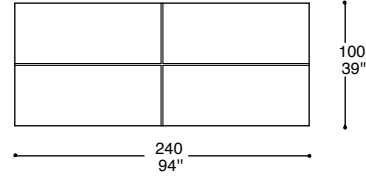

VAN 04

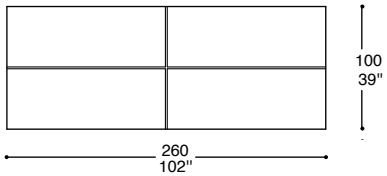

VAN 05

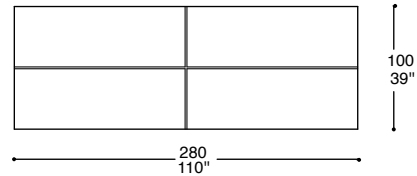

VAN 06

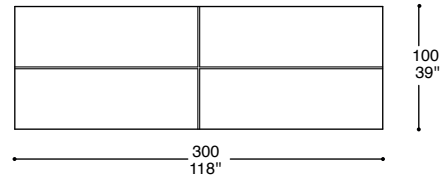

17 ▶

VAN 07

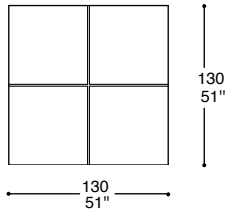

VAN 08

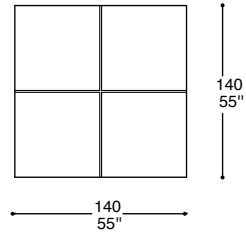

VAN 09

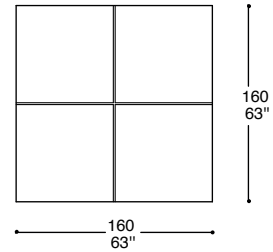

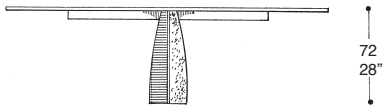

72
28"

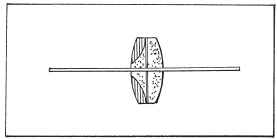

100
40"

WL 01
WL 40

200
79"

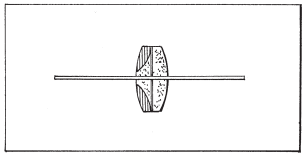

110
43"

WL 03
WL 42

220
87"

18 ▶

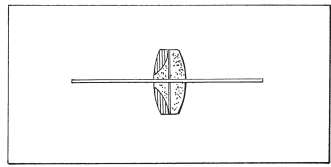

120
47"

WL 09
WL 44

240
95"

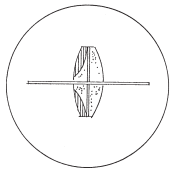

120
47"

WL 13
WL 52

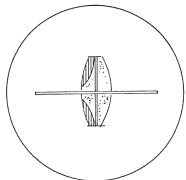

130
51"

WL 15
WL 54

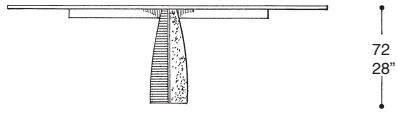

72
28"

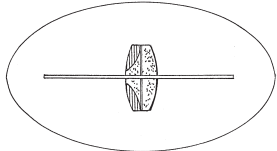

120
47"

WL 05

WL 46

200
79"

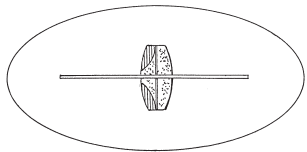

120
47"

WL 07

WL 48

220
87"

19 ▶

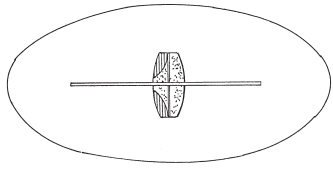

120
47"

WL 11

WL 50

240
95"

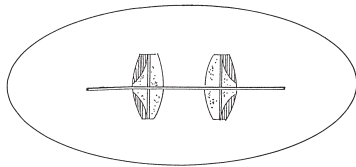

120
47"

WL 37

WL 72

260
102"

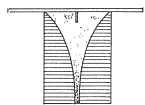

70
28"

WL 17

WL 56