

SR 218

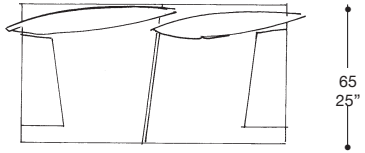

1 ▶

SR 219

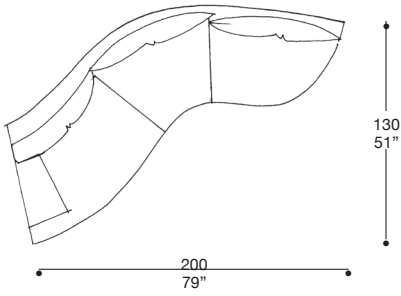

SR 220

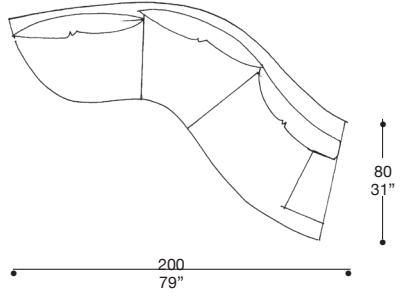

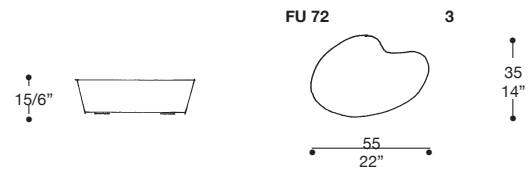
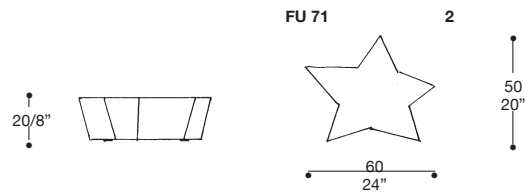
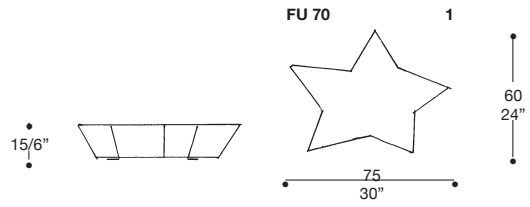

2 ▶

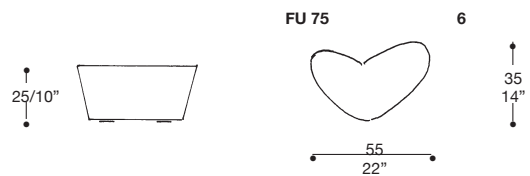
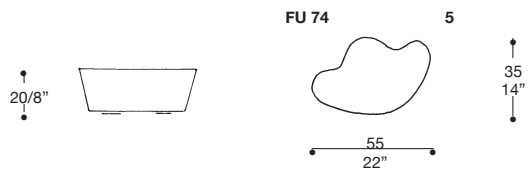
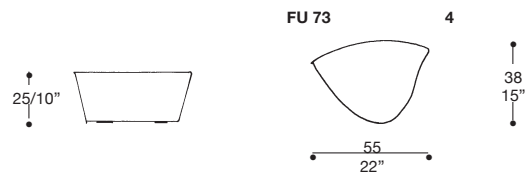

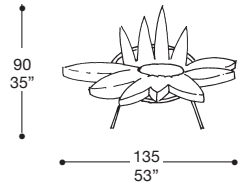

DA 20

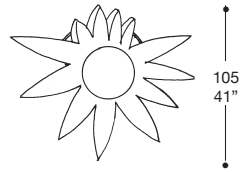

DA 25

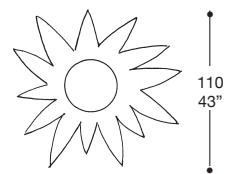

3 ▶

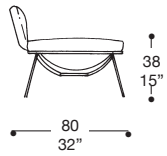

DA 30

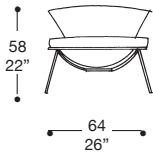

DA 31

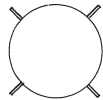
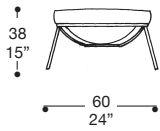

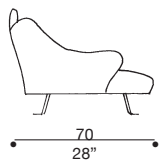

55  
22"

FL 12

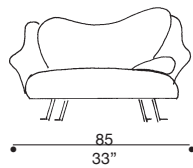

4 ▶

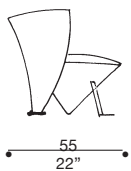

50  
20"

JD 04

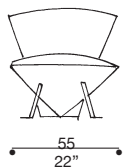

30  
12"

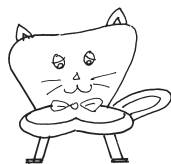

22  
9"

MI 10

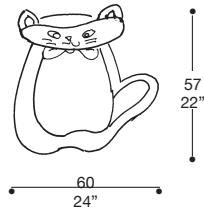

57  
22"

SK 01

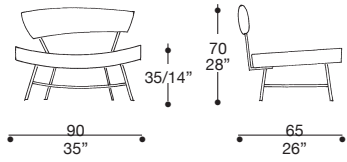

SK 02

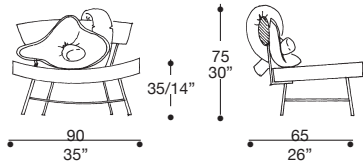

SK 03

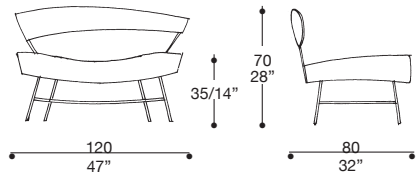

5 ▶

SK 04

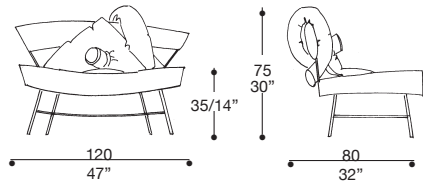

SK 05

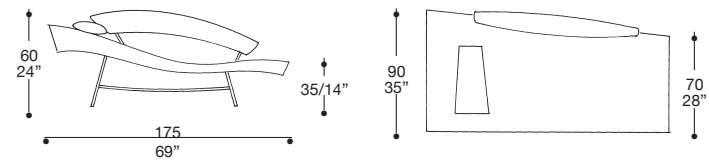

SK 06

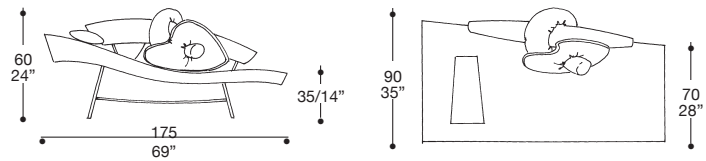



50  
20"

**TATO 02**

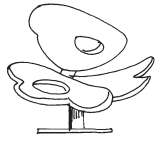

60  
24"

70  
28"

6 ▶

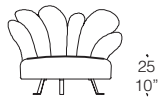

60  
24"  
25  
10"

75  
30"

**VIO 01**

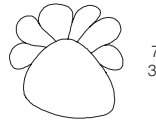

75  
30"

**VIO 02**

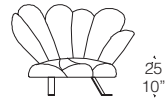

60  
24"  
25  
10"

80  
32"



95  
37"

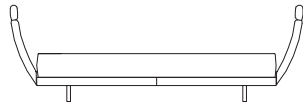
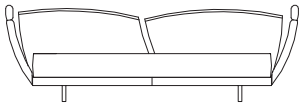
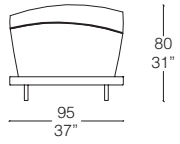

**AU 01** "A"

**AU 02** "B"

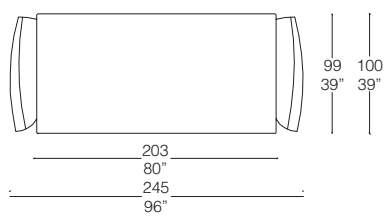
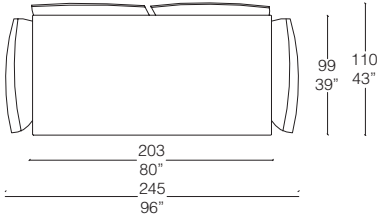

7 ▶

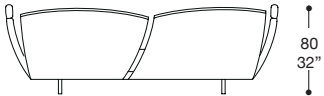

**AU 04** "C"

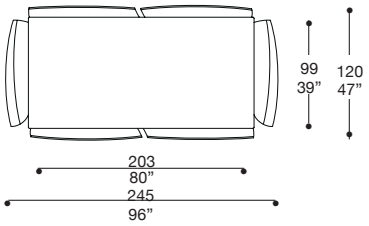

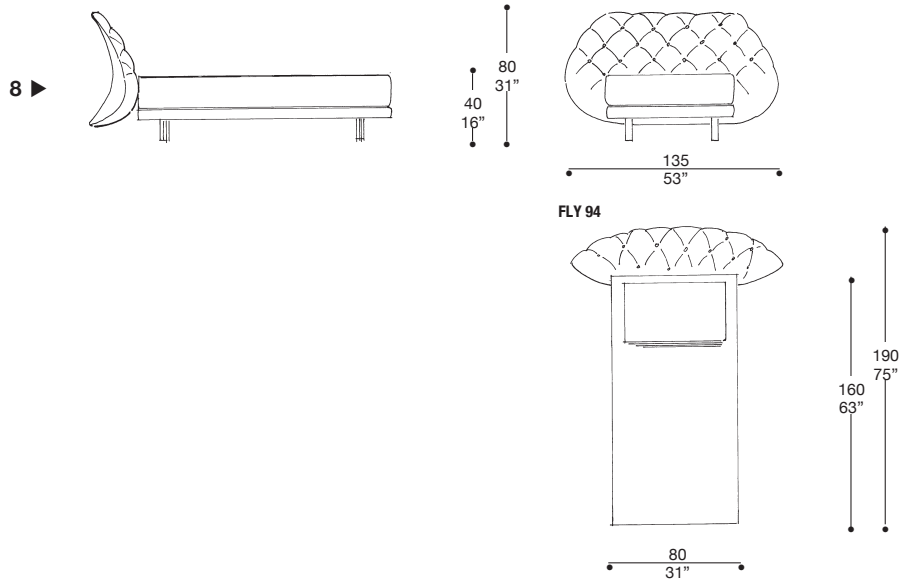
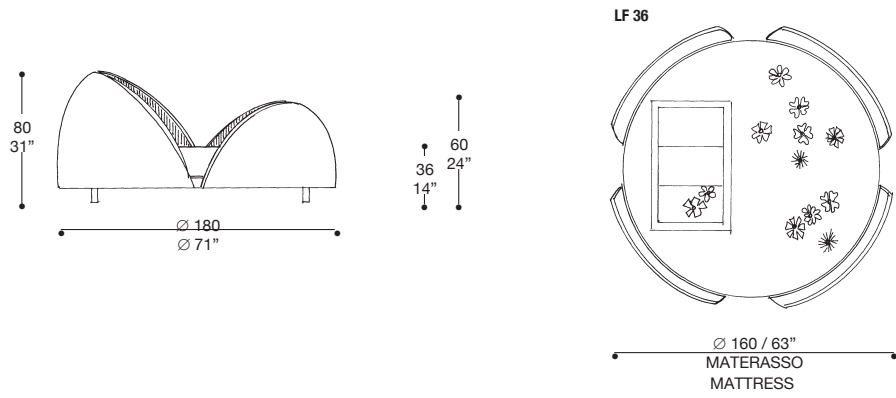



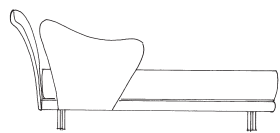

40  
16"

80  
32"

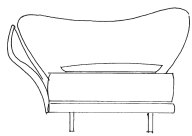

120  
47"

LF 05

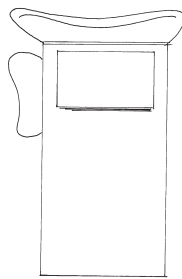

80  
31"

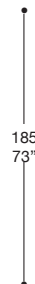

185  
73"

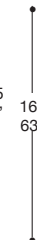

160  
63"

LF 06

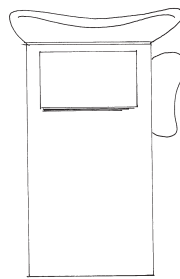

80  
31"

LF 04

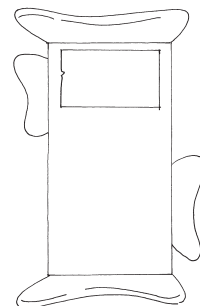

80  
31"  
120  
47"

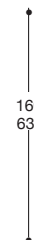

160  
63"

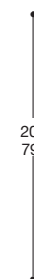

200  
79"

9 ▶

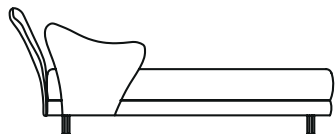

45  
18"

85  
34"

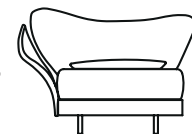

120  
47"

LF 11

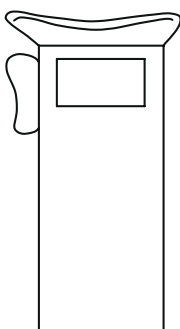

85  
33"

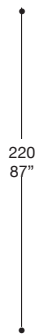

220  
87"

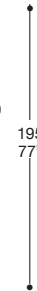

195  
77"

LF 12

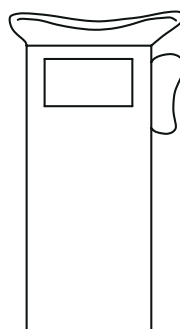

85  
33"

LF 10

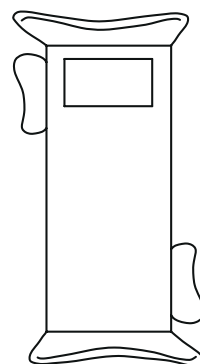

85  
33"  
120  
47"

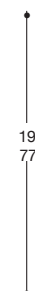

195  
77"

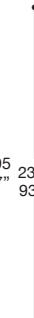

235  
93"

FR 10 ST

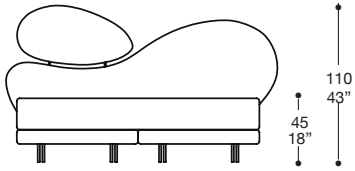

FR 12 QS

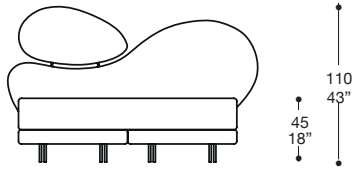

FR 14 KS

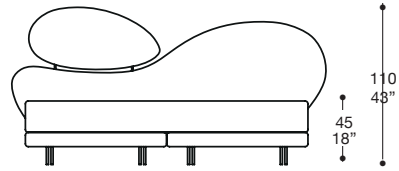

FR 16

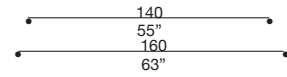
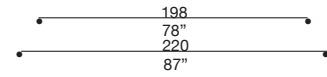
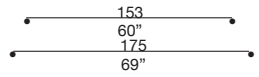
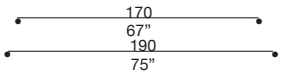
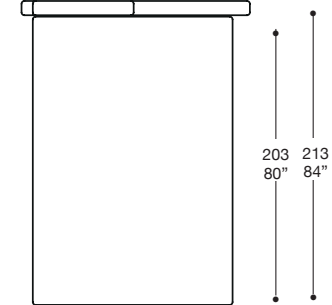
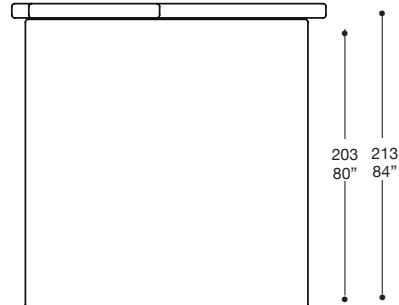
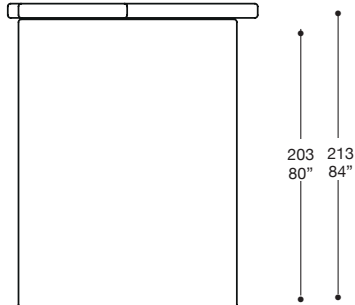
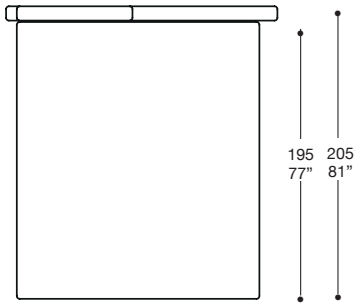
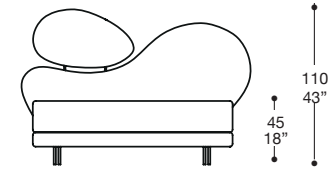

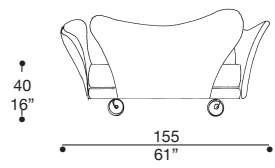

LF 08

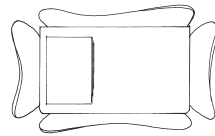

115 x 65 / 45°  
x 26"  
MATERASSO



11 ►

LG 27

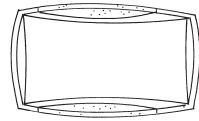
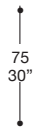
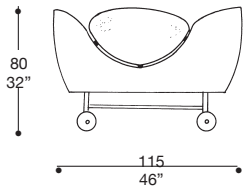

GPL 01

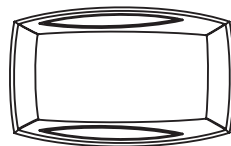
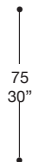
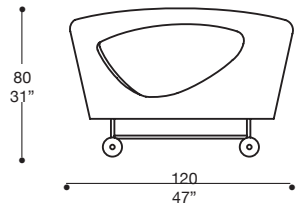

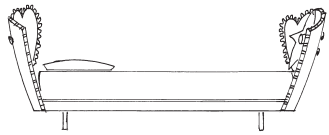

TESTATA INTERNA  
INSIDE HEADBOARD

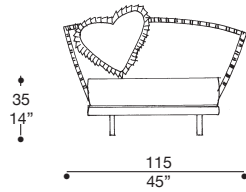

PEDIERA INTERNA  
INSIDE FEETBOARD

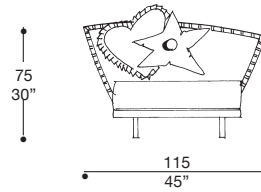

TESTATA ESTERNA  
OUTSIDE HEADBOARD

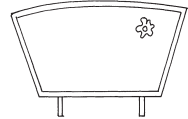

PEDIERA ESTERNA  
OUTSIDE FEETBOARD

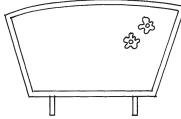

RL 05

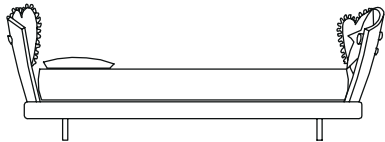
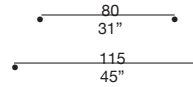
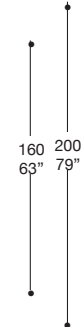
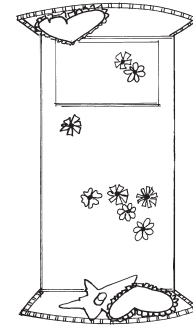

TESTATA INTERNA  
INSIDE HEADBOARD

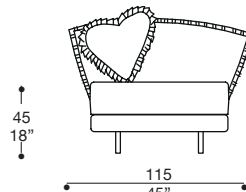

PEDIERA INTERNA  
INSIDE FEETBOARD

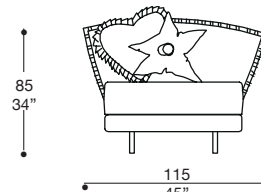

TESTATA ESTERNA  
OUTSIDE HEADBOARD

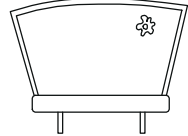

PEDIERA ESTERNA  
OUTSIDE FEETBOARD

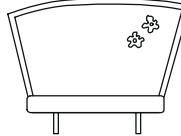

RL 07

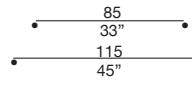
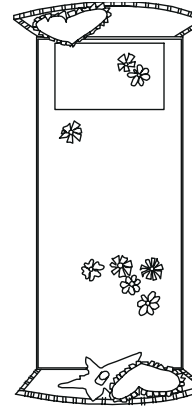

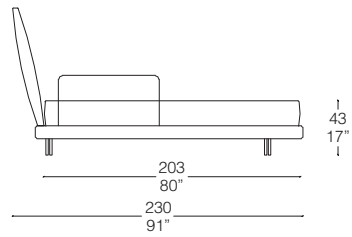
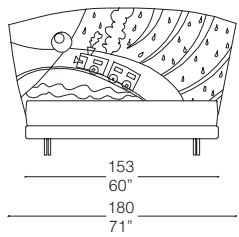

TRE 01

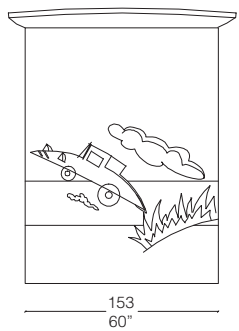

TRE 02 COPRILETTO BEDSPREAD

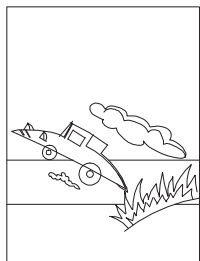

TRE 03

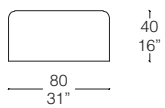

13 ►

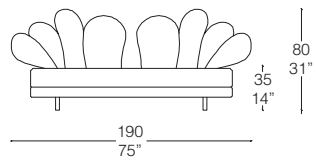
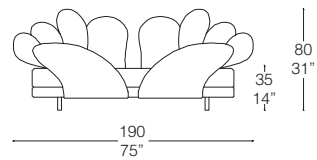

VIO 10

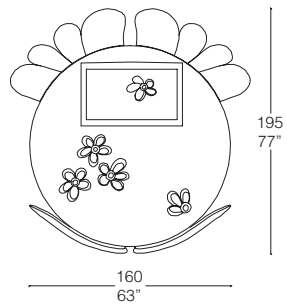

VIO 11

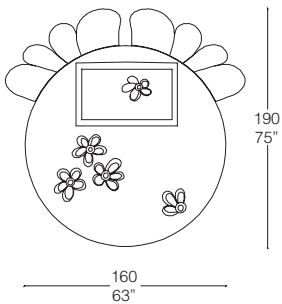

VIO 12 COPRILETTO BEDSPREAD

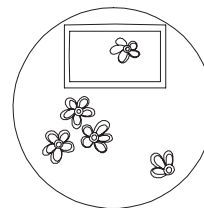

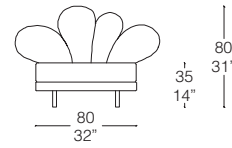
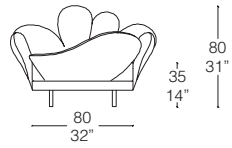

VIO 13 "A"

VIO 15 "C"

VIO 14 "B"

VIO 16 "D"

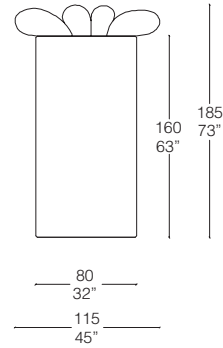
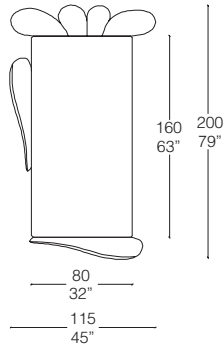
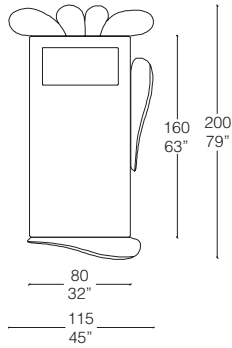
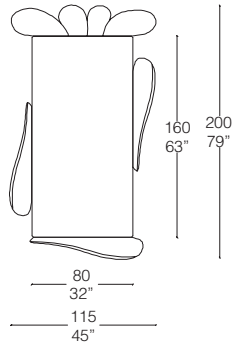

14 ▶

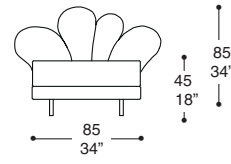
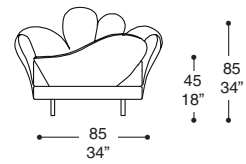

VIO 18 "E"

VIO 20 "G"

VIO 19 "F"

VIO 21 "H"

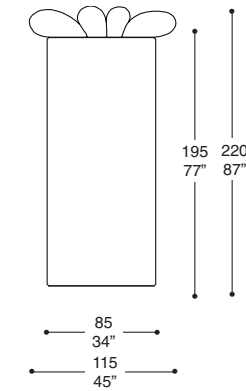
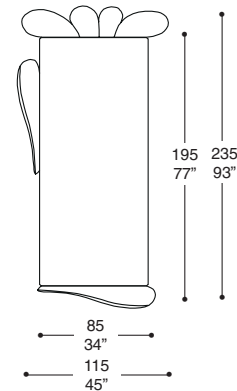
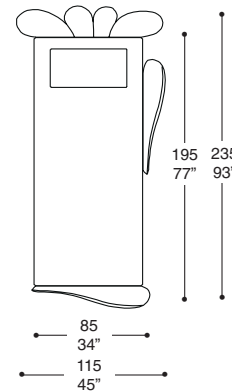
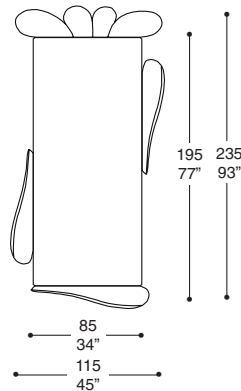

CB 10

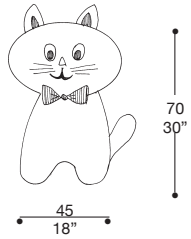

CB 11

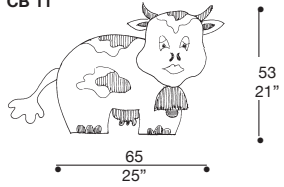

CB 12

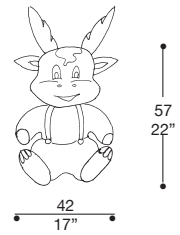

15 ▶

CB 13

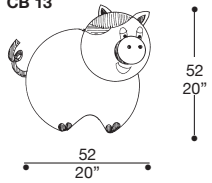

CB 14

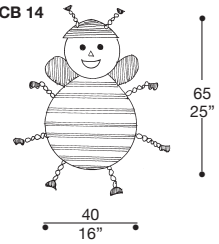

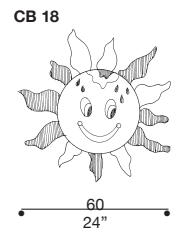
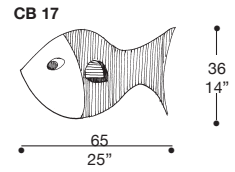
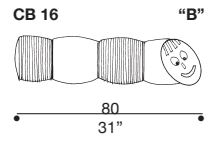
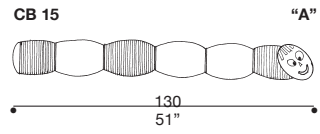

16 ▶

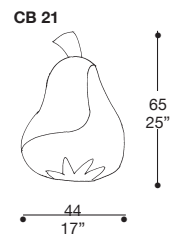
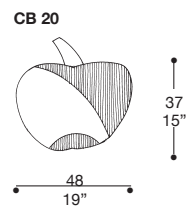





ZO 33

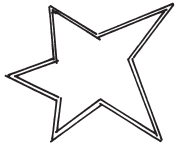

ZO 34



ZO 35

17 ▶



ZO 36



ZO 39

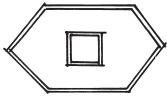

ZO 37



ZO 40



ZO 38



ZO 41

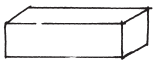

ZO 42



ZO 43

---

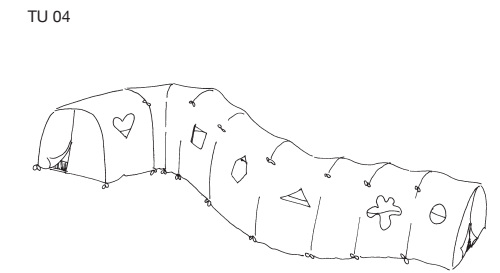
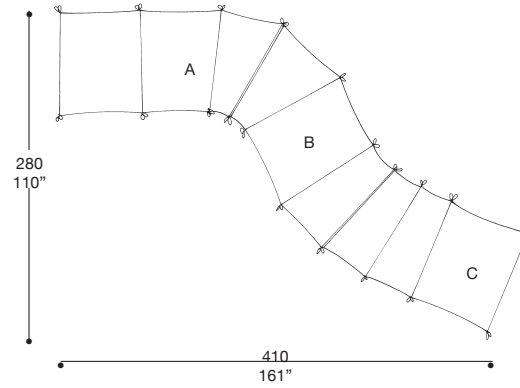
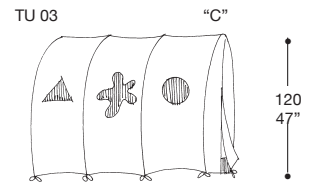
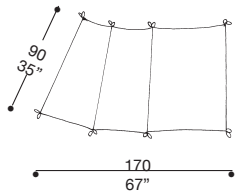
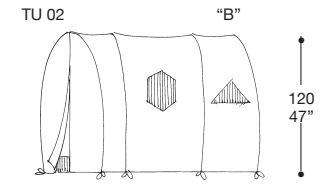
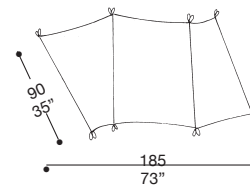
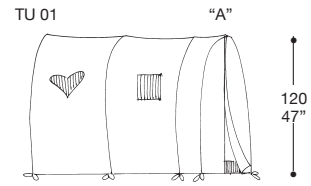
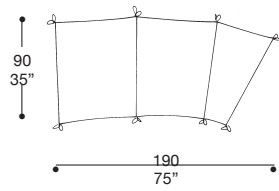

18 ▶

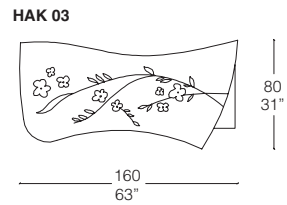
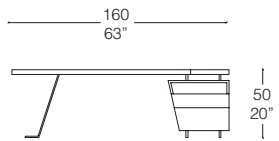

AU 10



300  
118"

240  
94"

Vista interna / Internal view  
struttura / frame

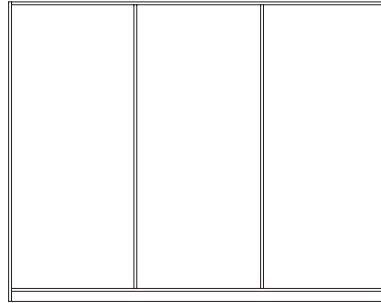

97 98 97  
38" 39" 38"

Ante scorrevoli / Sliding doors



63  
25"

AU 11



300  
118"

240  
94"

Vista interna / Internal view  
struttura / frame

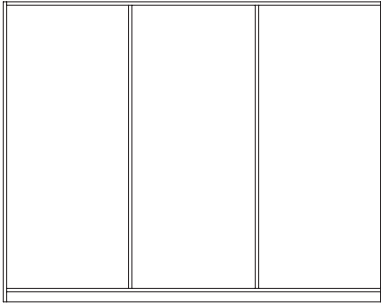

97 98 97  
38" 39" 38"

Ante complanari / Complanar doors



60  
24"

AU 12



300  
118"

240  
94"

Vista interna / Internal view  
struttura / frame

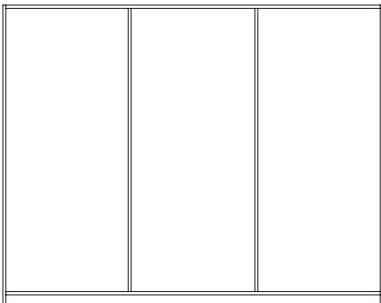

97 98 97  
38" 39" 38"

Ante battenti / Hinged doors

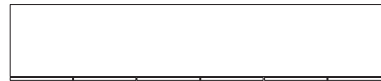

60  
24"

AU 13

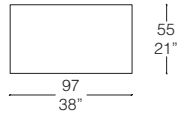

AU 14 SX

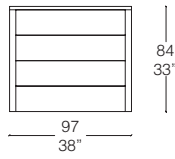

AU 16

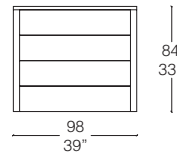

AU 15 DX

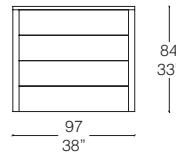

AU 17 SX

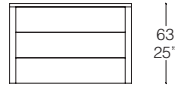

AU 19

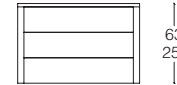

AU 18 DX

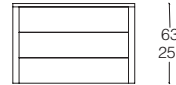

AU 20 SX

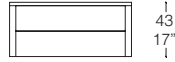

AU 22

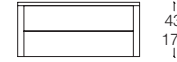

AU 21 DX

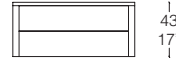

AU 23

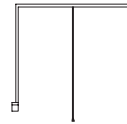

AU 24



20 ▶

CIL 01

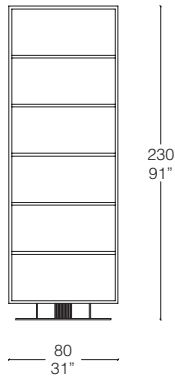

CIL 02

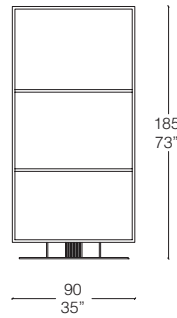

CIL 03

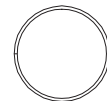
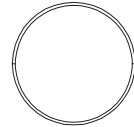
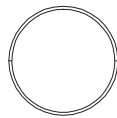
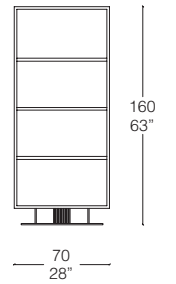

TA 51

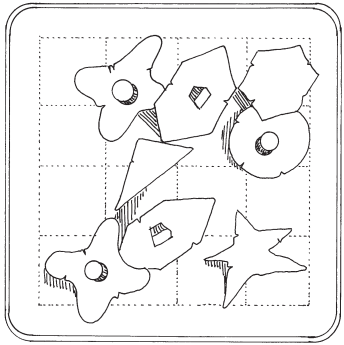

170  
69"

170  
69"

TA 67

"4"

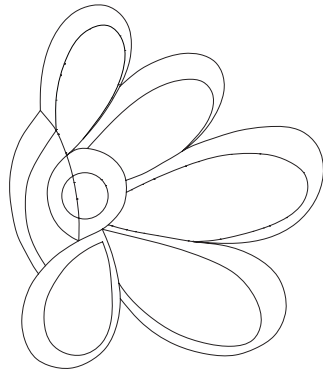

240  
95"

210  
83"

TA 72

"4A"

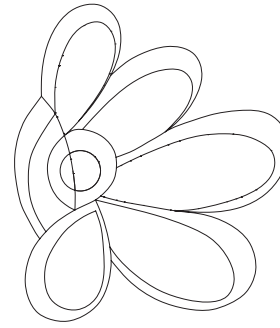

200  
79"

180  
71"

21 ►

TA 52

"1"

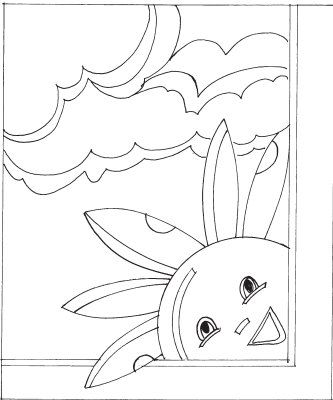

TA 53

"2"

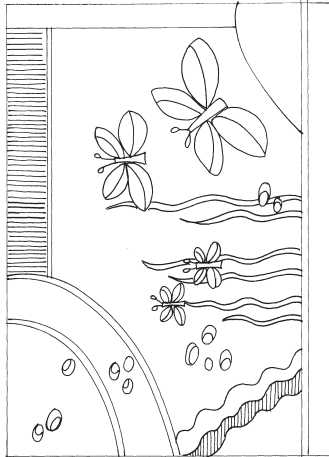

TA 54

"3"

