

AD 03

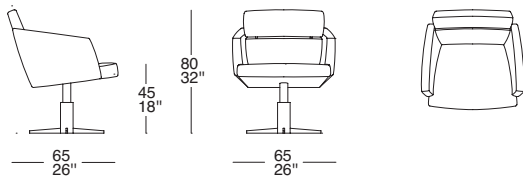

AD 02

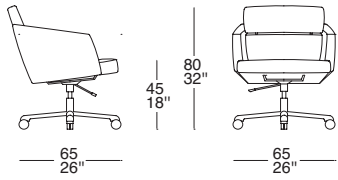

2 ▶

AD 04

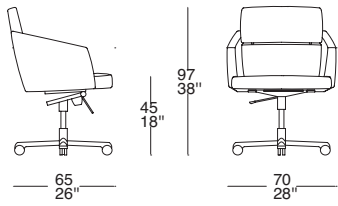

AD 05

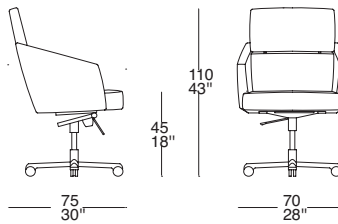

CL 03

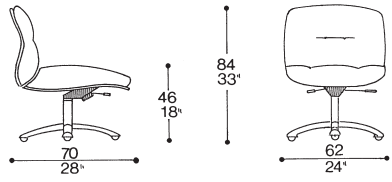

CL 02

3 ▶

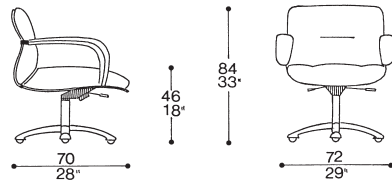

CL 01

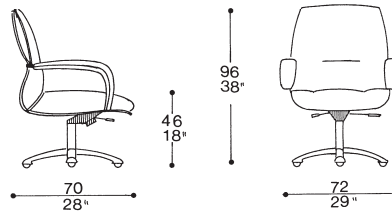

HM 16
HM 18

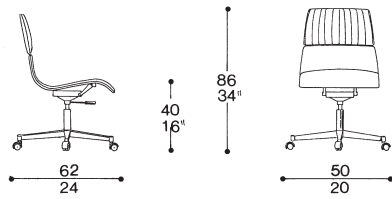

HM 19
HM 21

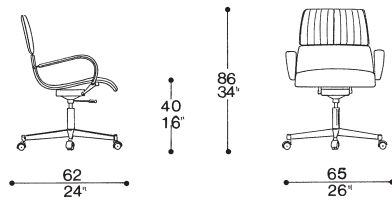

4 ▶

HM 35

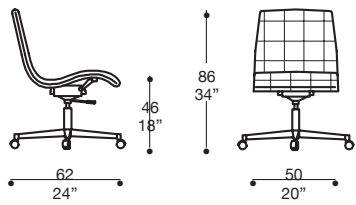

HM 36

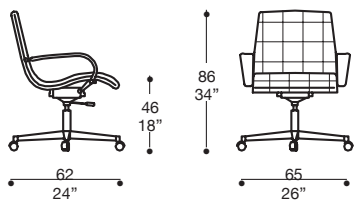

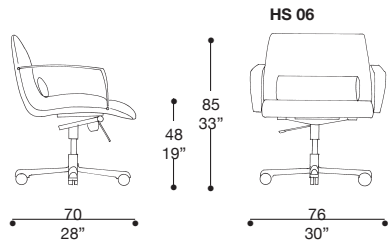
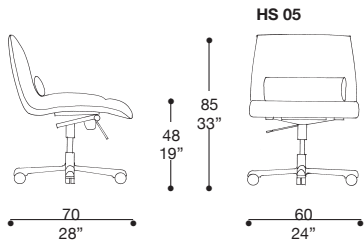

5 ▶

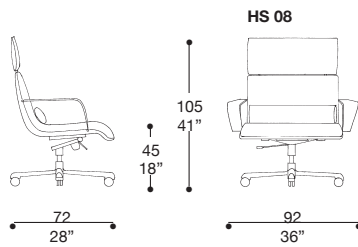
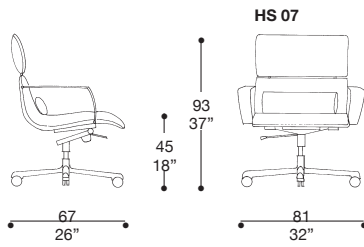

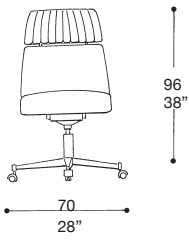
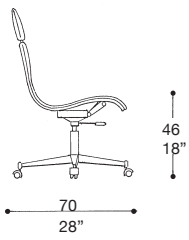

HS 01

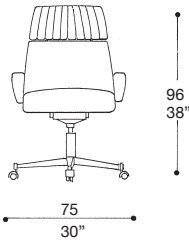
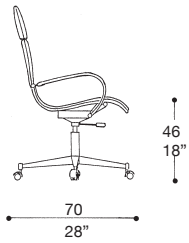

HS 02

6 ▶

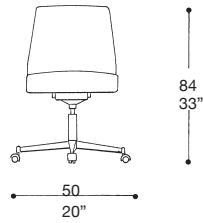
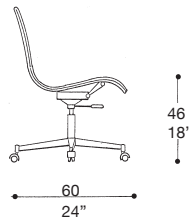

HS 03

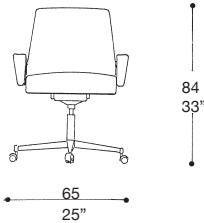
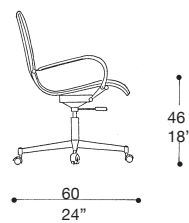

HS 04

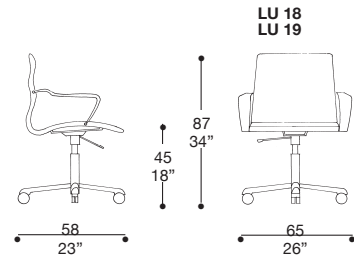
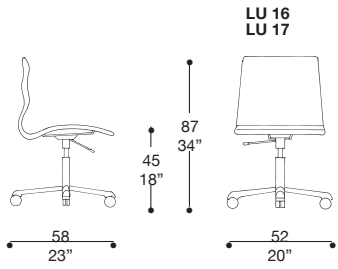

7 ▶

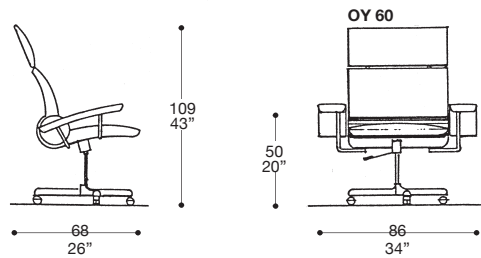
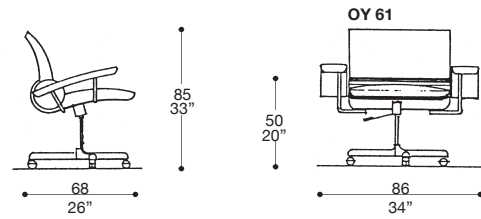
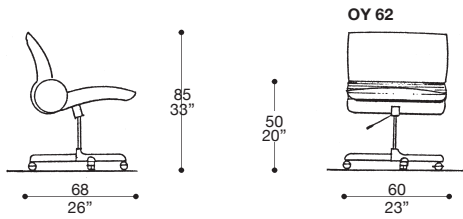

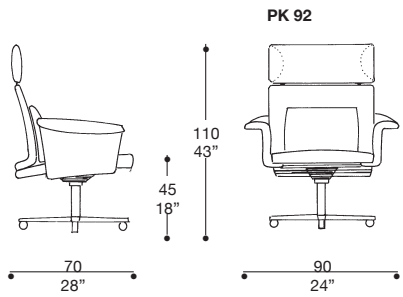
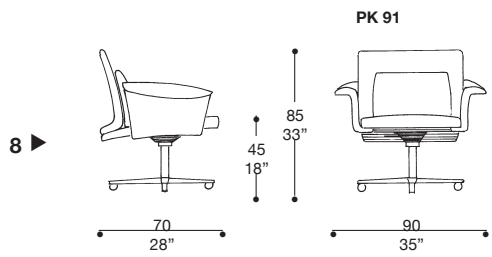
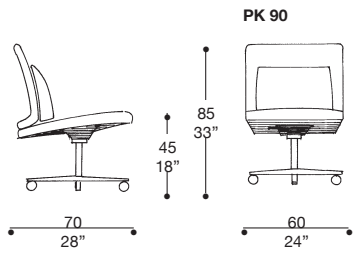

AC 70

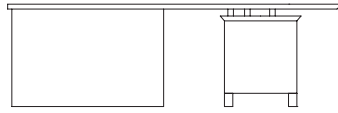

58
23"

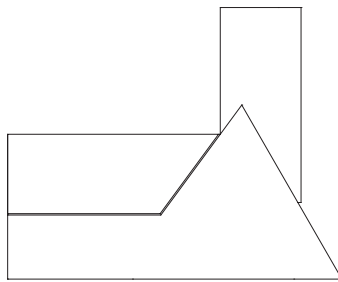

240
94"

74
29"

AC 71

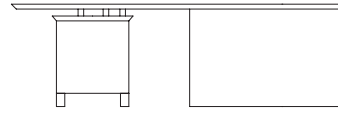

58
23"

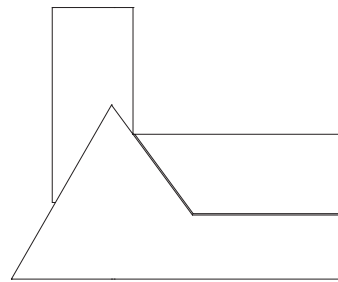

240
94"

125
49"

195
77"

125
49"

9 ▶

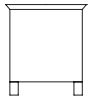

58
23"

65
26"

AC 72

SX

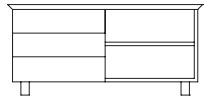

140
55"

AC 73

DX

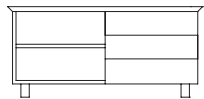

140
55"

65
26"

AC 74



70
27"

60
24"

GE 50

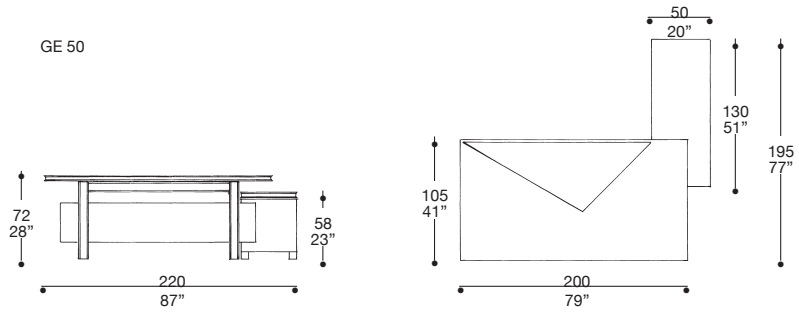

GE 51

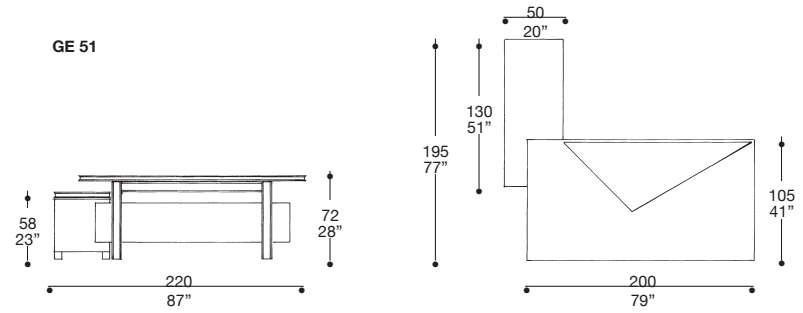

GE 52

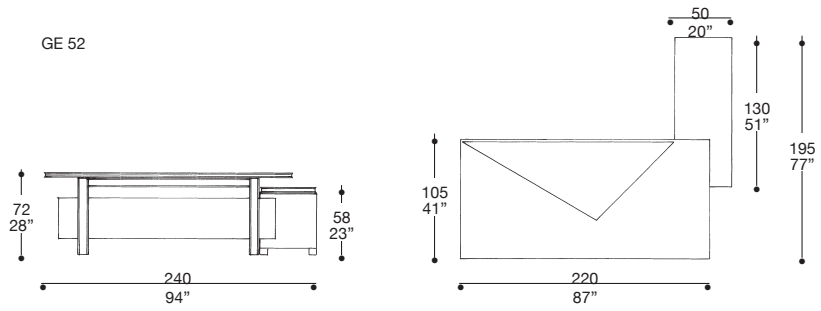

GE 53

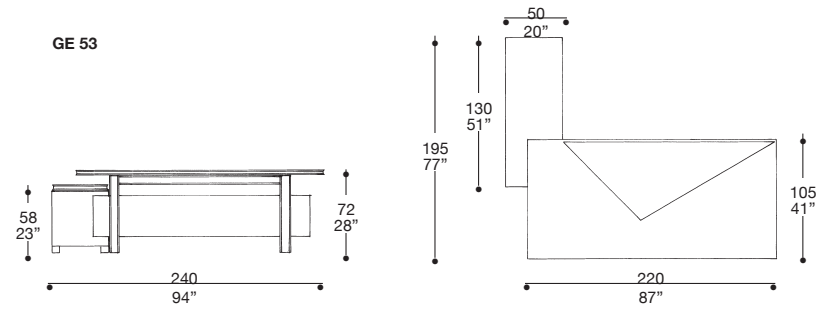

GE 54

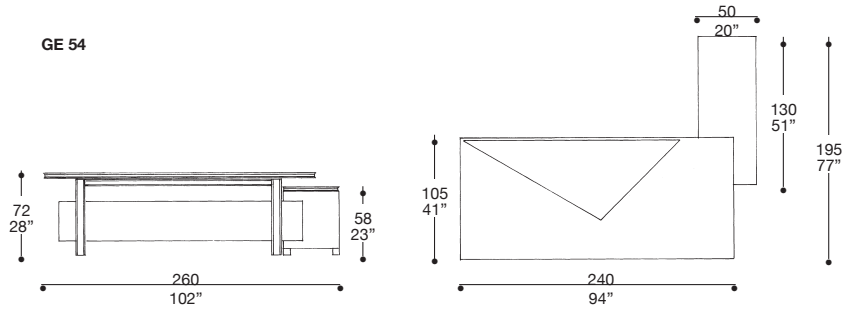

GE 55

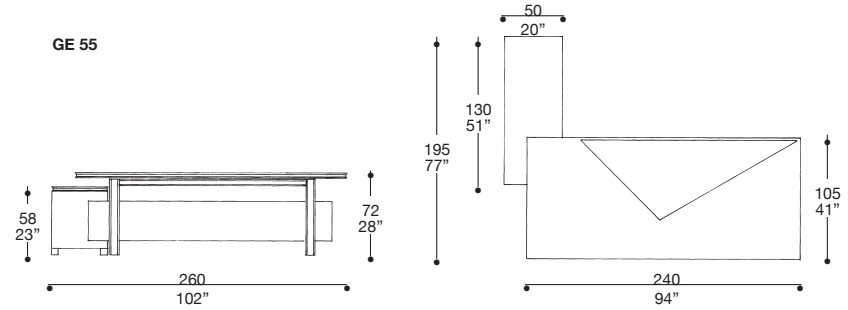

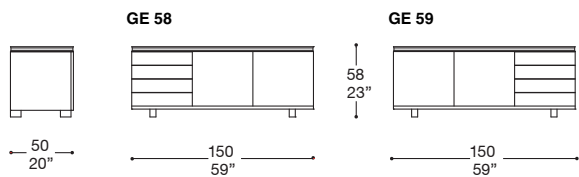
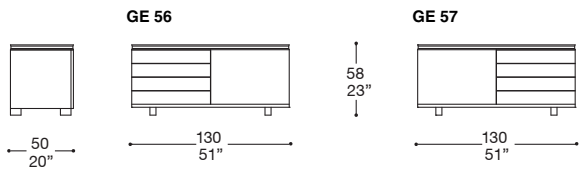

11 ►

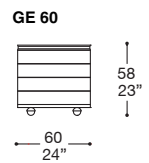

HAK 01

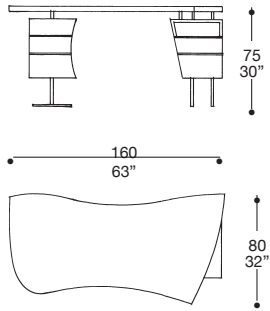

HAK 02

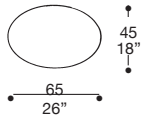

12 ▶

MI 50

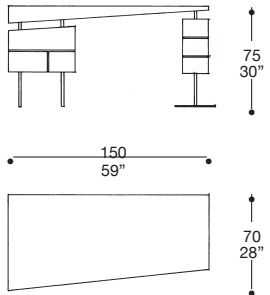

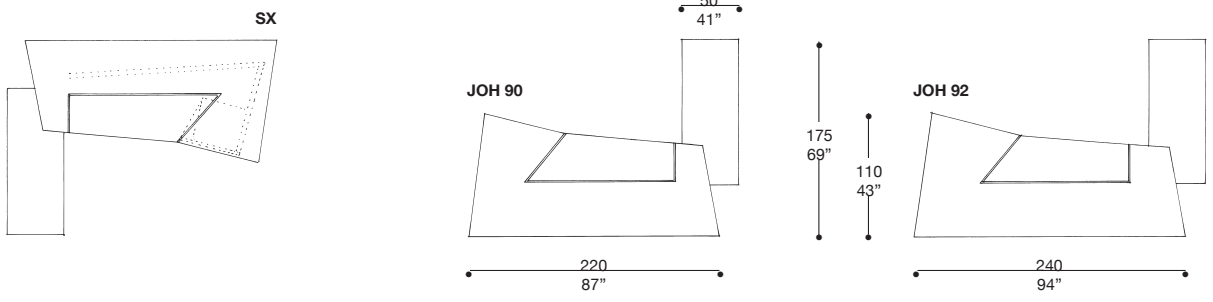
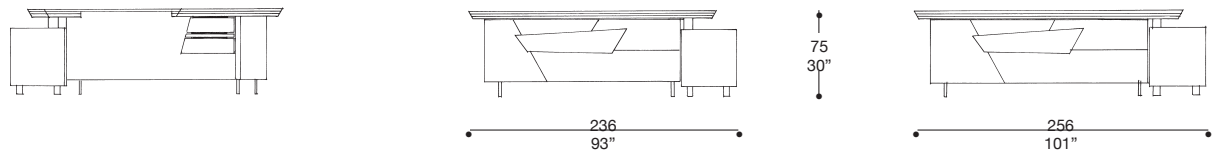

13 ▶

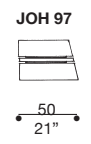
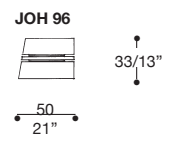
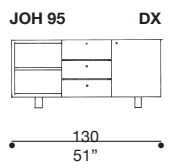
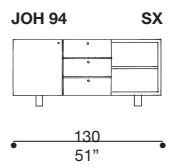
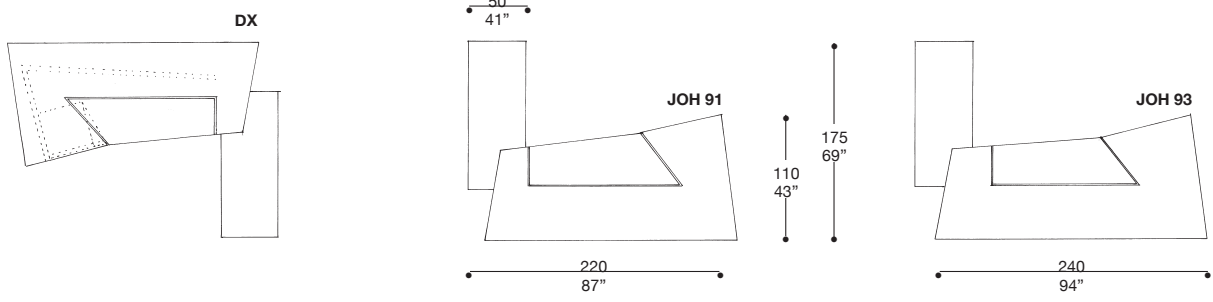
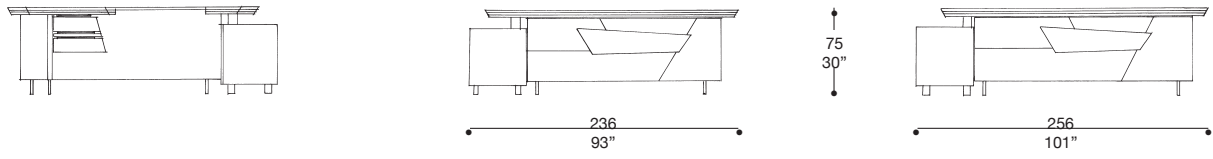

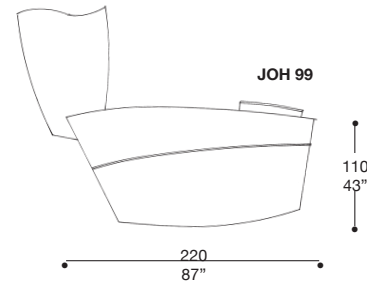
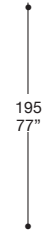
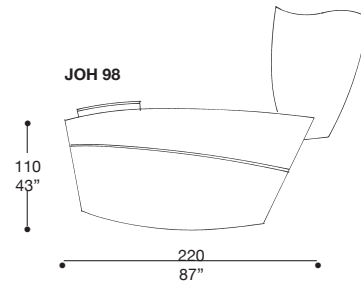
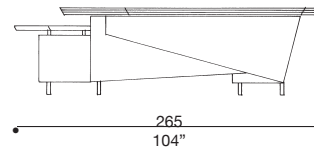
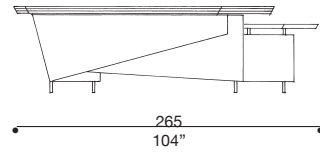
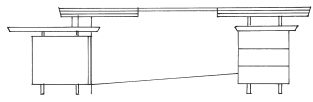

14 ▶

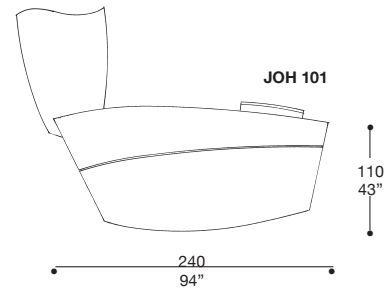
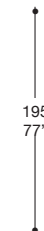
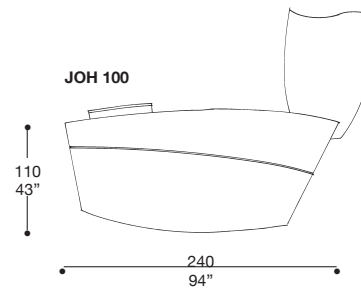
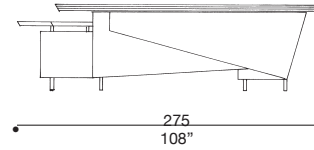
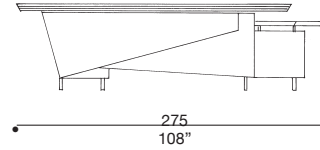
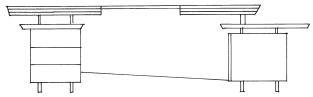

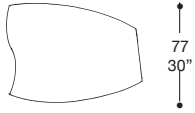

JOH 102 SX

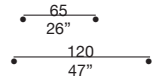
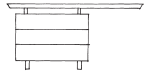

JOH 103 SX

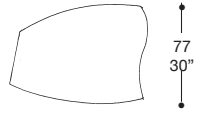
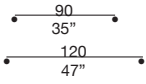
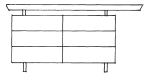

15 ▶

JOH 105 DX

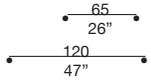
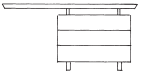

JOH 106 DX

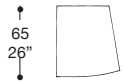
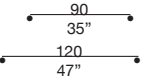
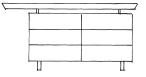

JOH 104



JOH 107



OY 53 DX

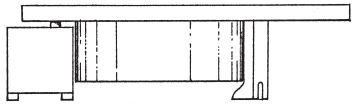

260
102"

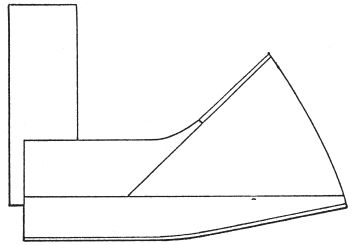

240
95"

73
29"

OY 52 SX

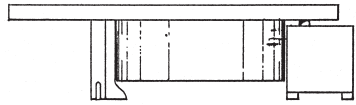

260
102"

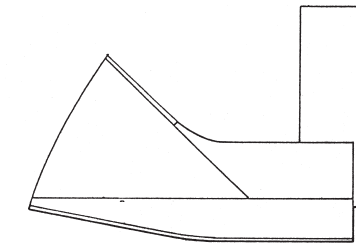

240
95"

180
71"

16 ▶

OY 51 DX

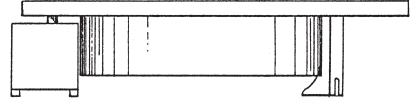

300
118"

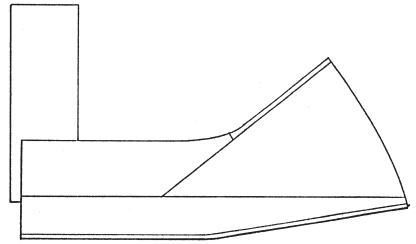

280
110"

73
28"

OY 50 SX

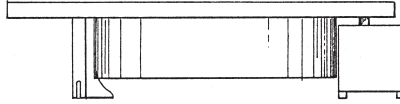

300
118"

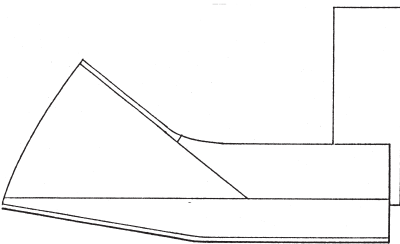

280
110"

180
71"

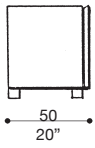

58
23"

OY 54

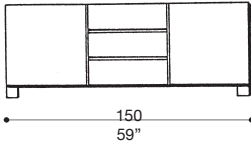

150
59"

58
23"

OY 55

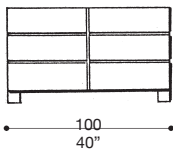

100
40"

58
23"

OY 56

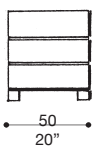

50
20"

54
21"

OY 57

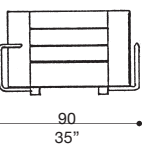

90
35"

60
23"

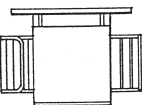

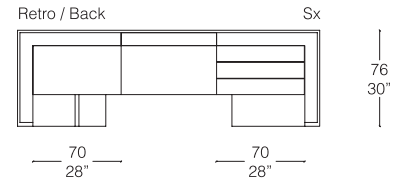
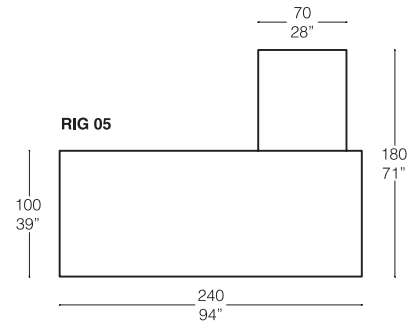
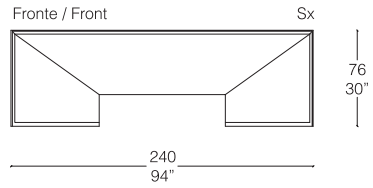

18 ▶

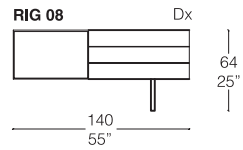
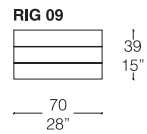
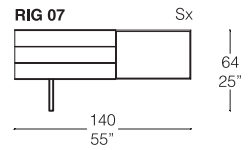
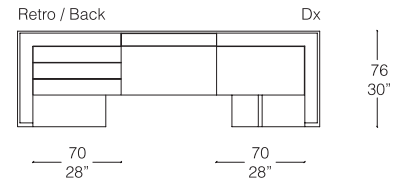
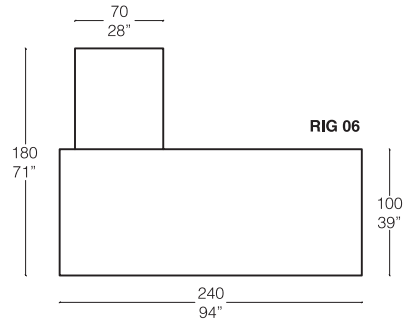
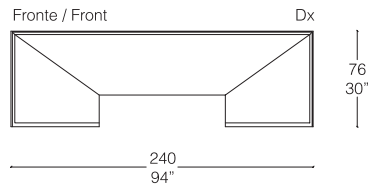

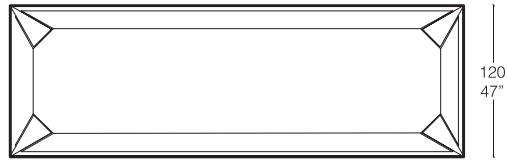
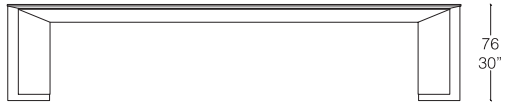

RIG 01

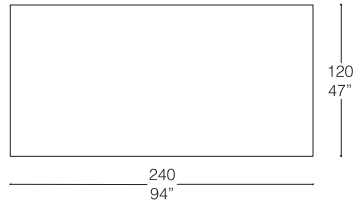

RIG 02

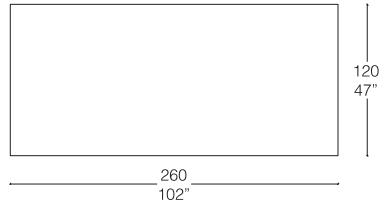

RIG 03

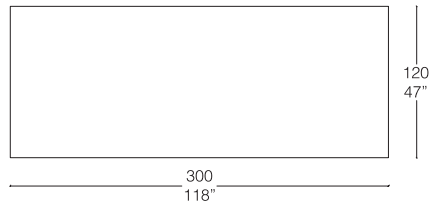

RIG 04

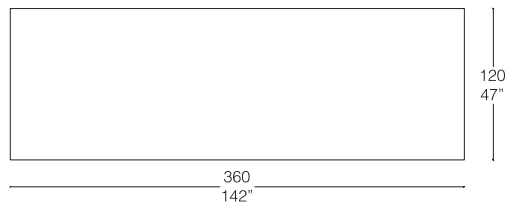

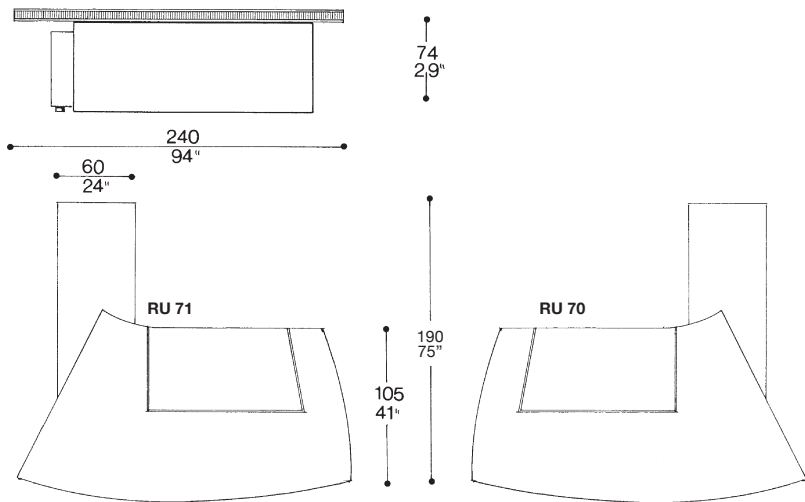

20 ▶

RU 72

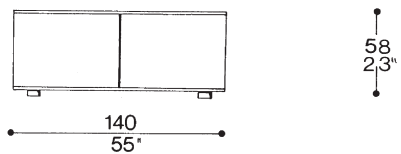

RU 73

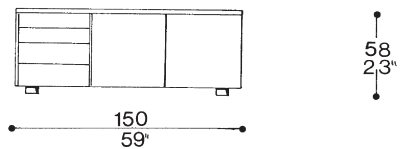

RU 74

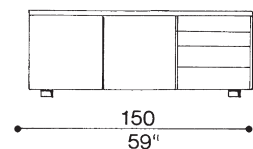

RU 75



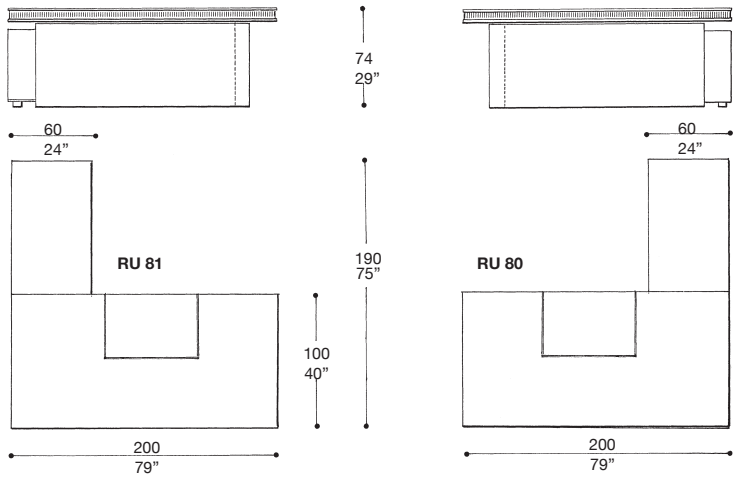

21 ▶

