

AM 01

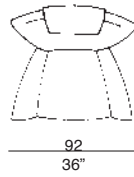

AM 02

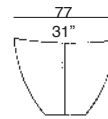
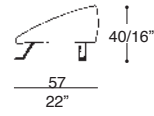

ARL 01

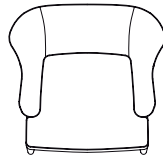
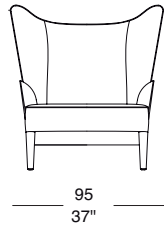
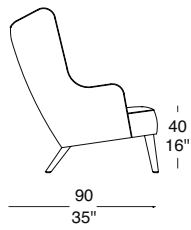

AS 01

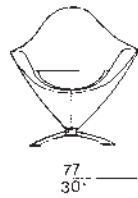
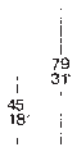
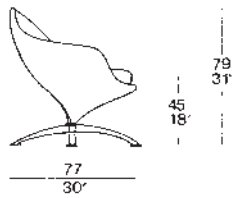

AS 03

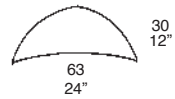

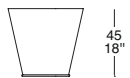

CN 20

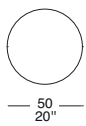

CN 21

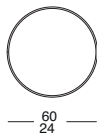

CN 22

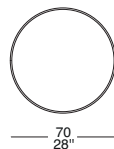

CN 23

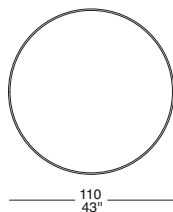

CN 24

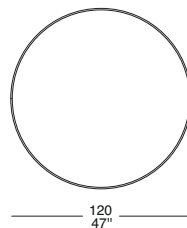

CN 25

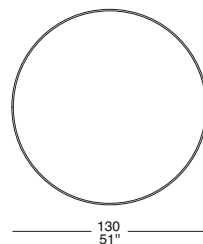

3 ▶



CN 26

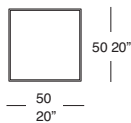

CN 27

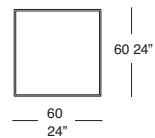

CN 28

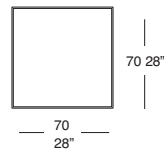

CN 29

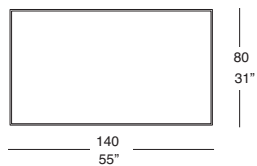

CN 30

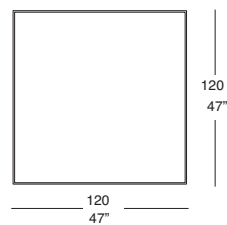

CN 31

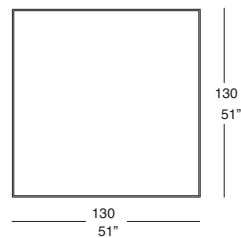

CN 32

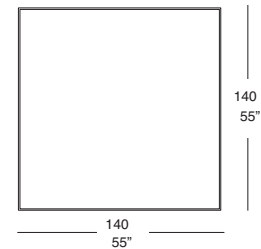

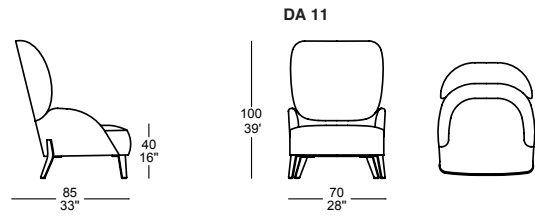
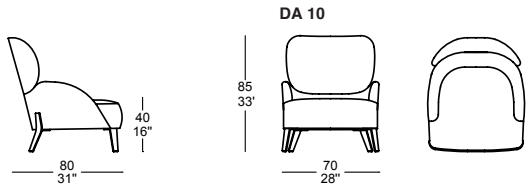

5 ▶

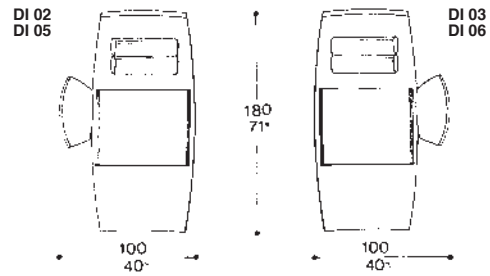
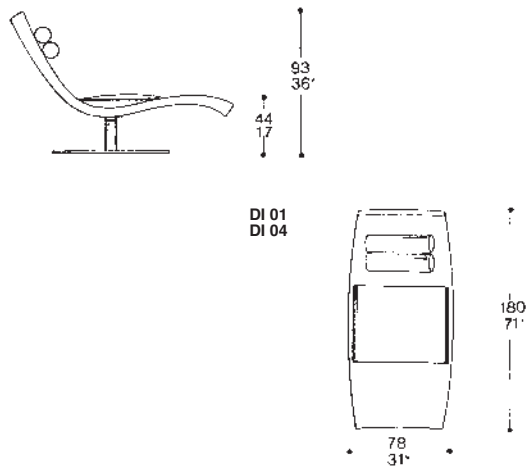

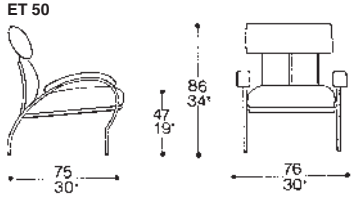
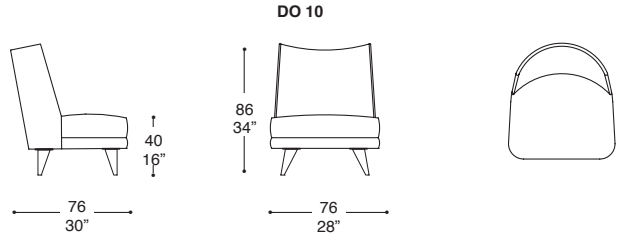

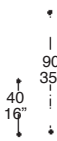
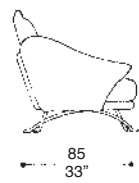
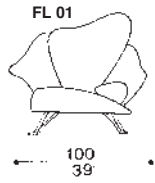

FL 10



FL 03

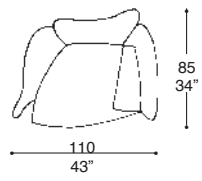
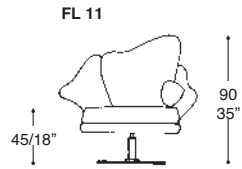
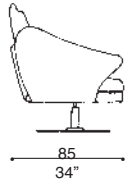

FL 02

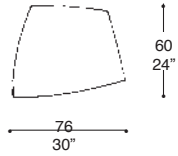

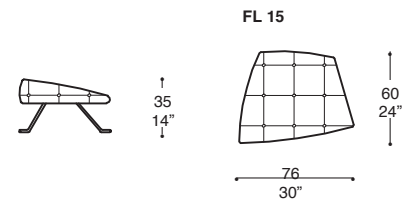
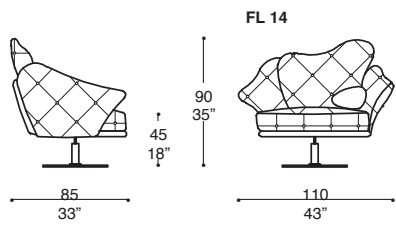
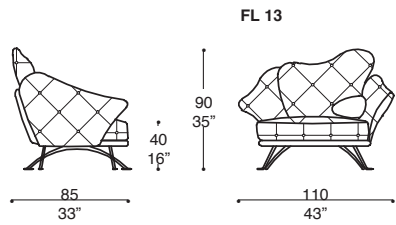

FL 16

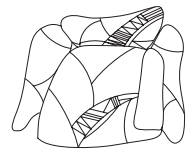
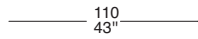
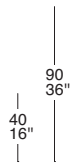

FL 17

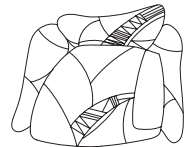
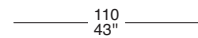
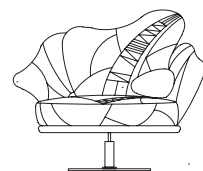
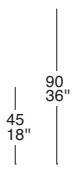

GEO 01

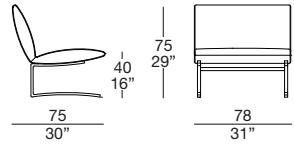

GEO 02

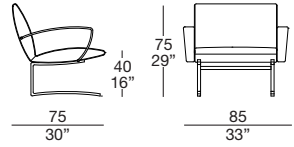

GEO 03

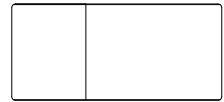
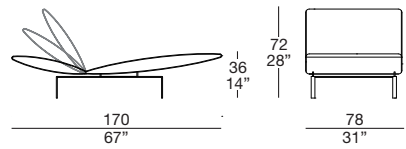

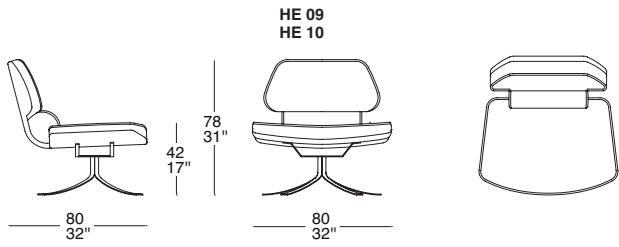
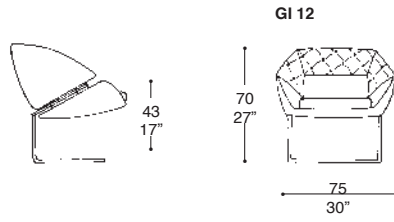
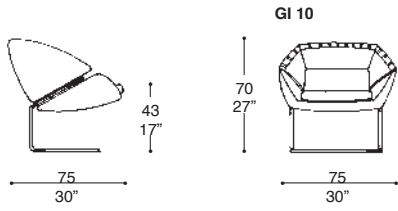

17 ▶

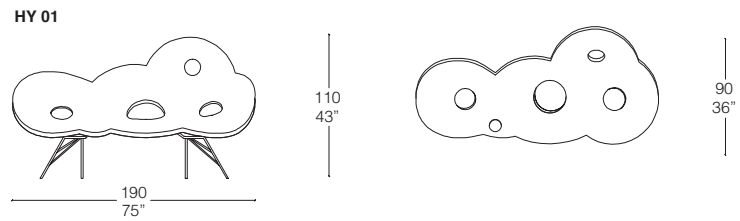
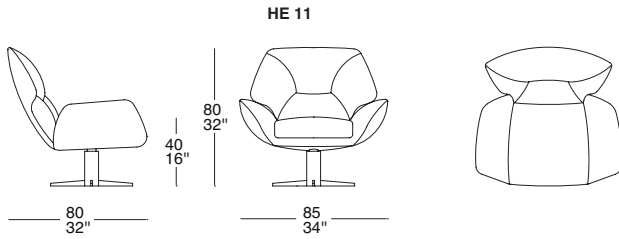

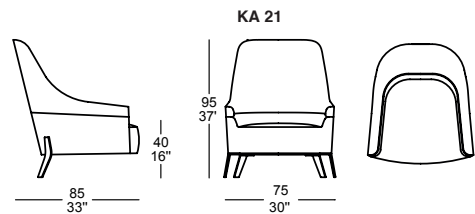
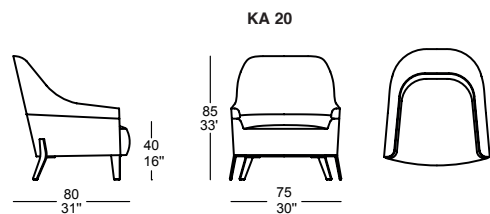
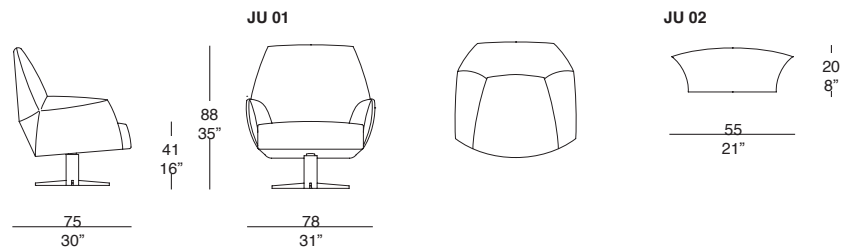
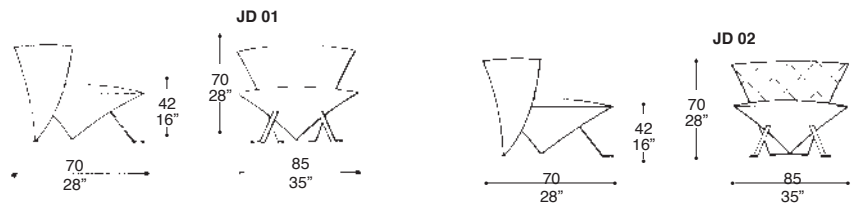

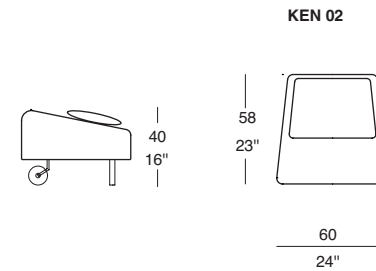
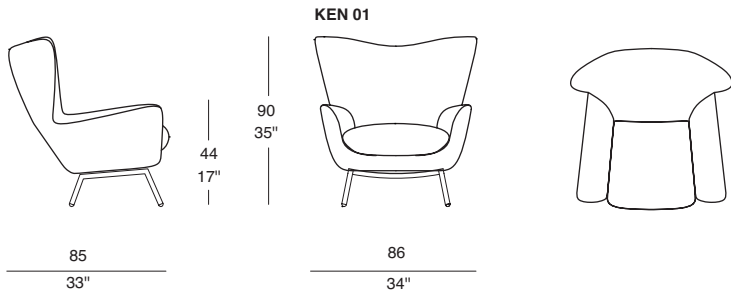
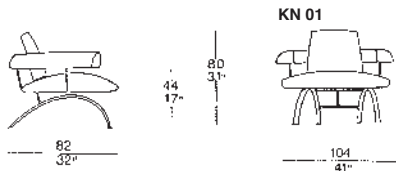

21 ▶

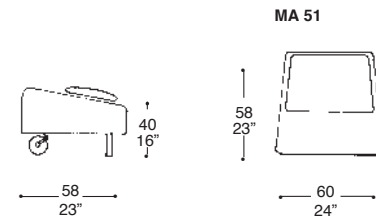
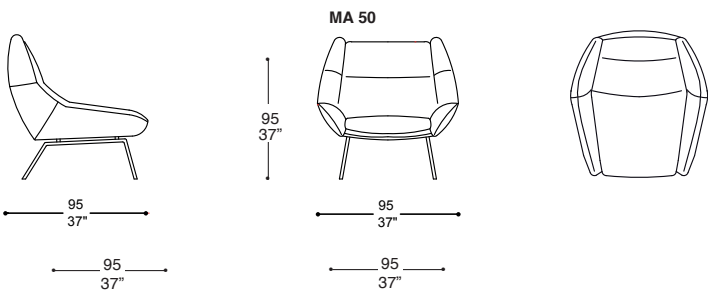
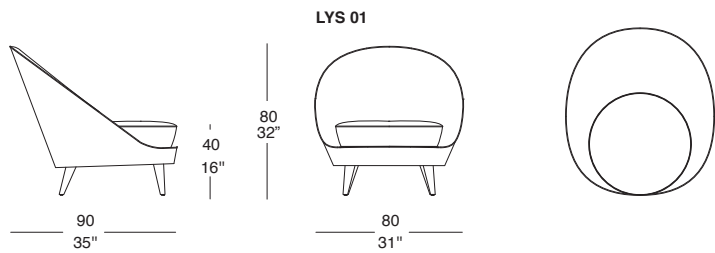

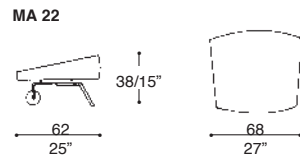
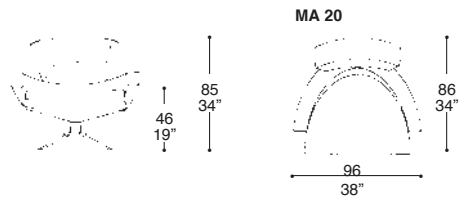
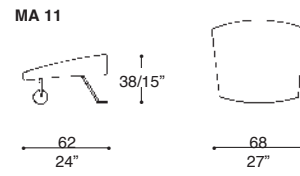
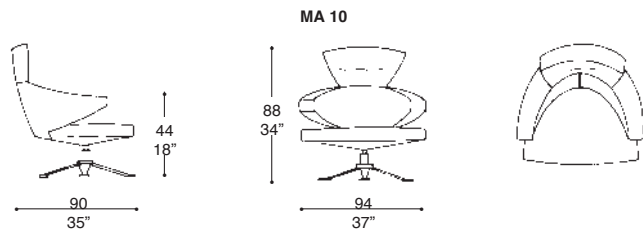

23 ▶

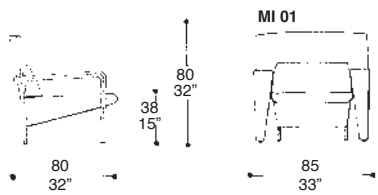
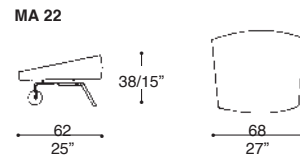
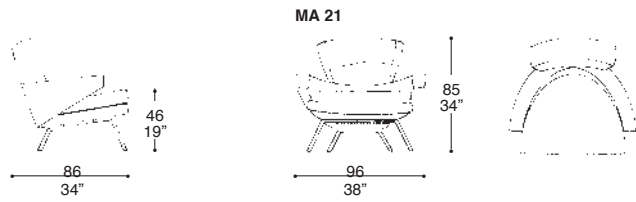

NA 50

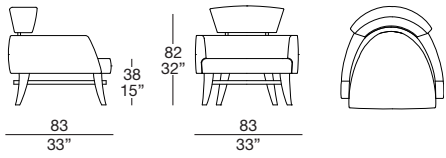

25 ▶

NI 10

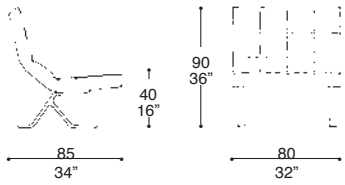

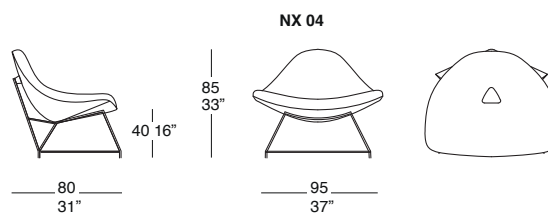
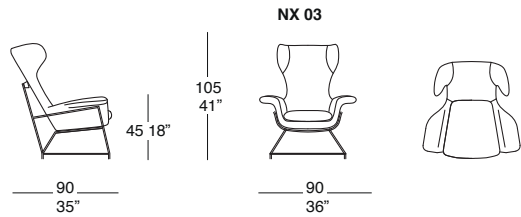
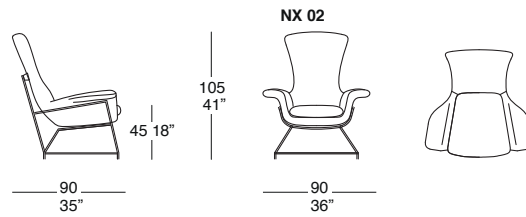
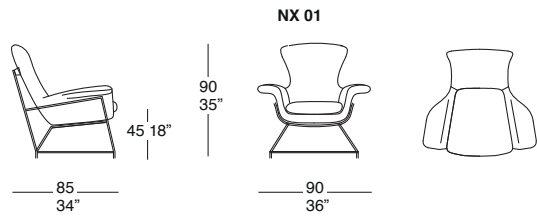

27 ▶

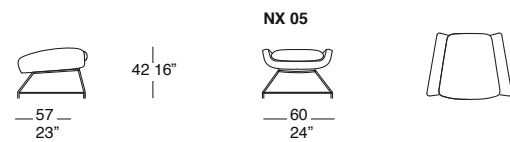
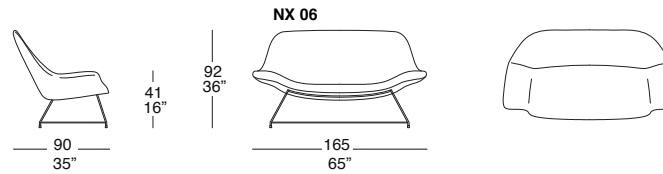
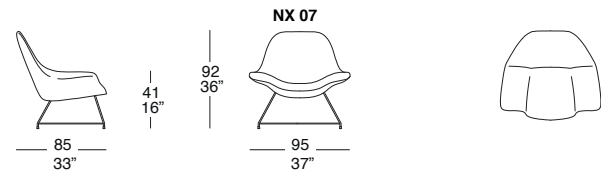

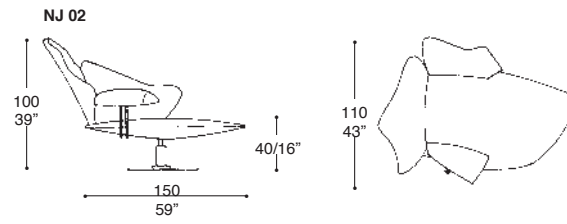
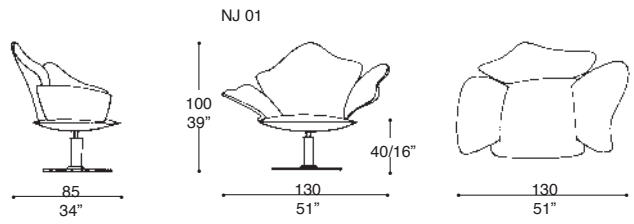

29 ▶

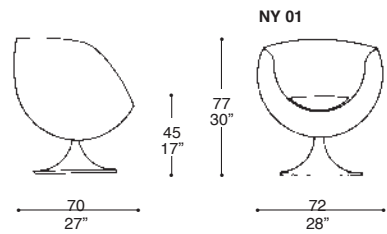
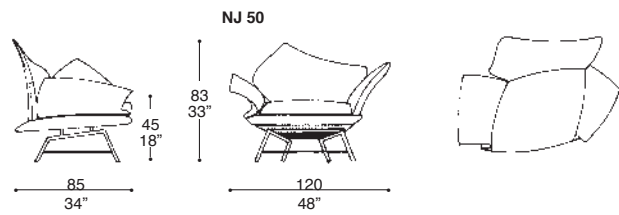

PK 50

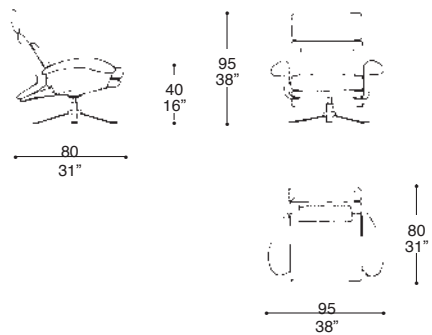

PK 51

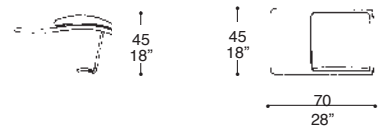

31 ►

PK 52

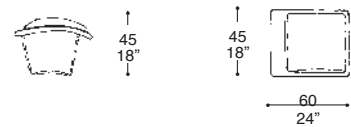

PK 15

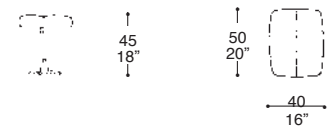

PK 93

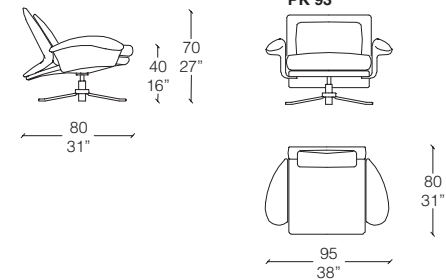

SX 01
SX 04

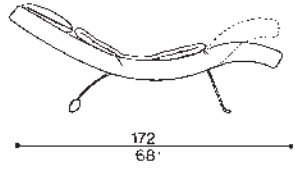

80
32"

SX 03
SX 06

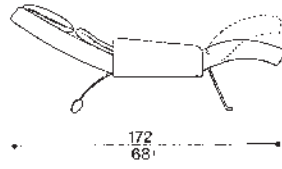

40
16"

SX 02
SX 05

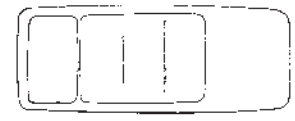
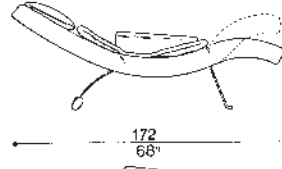

80
32"



92
36"



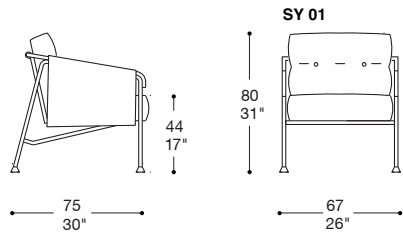
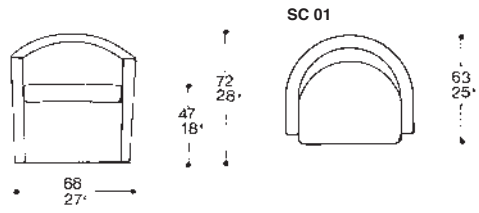

35 ▶

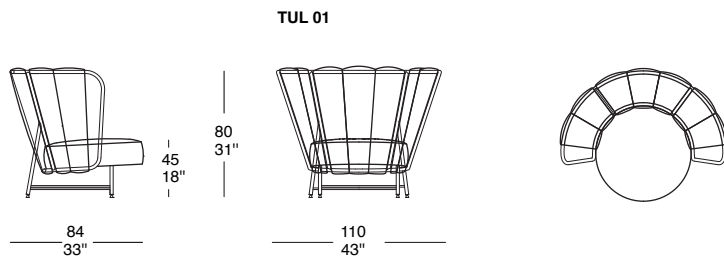
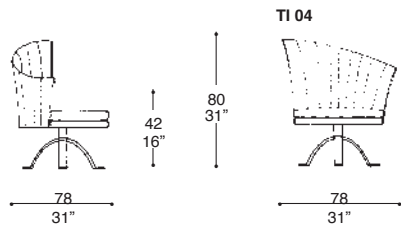

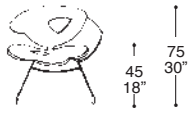

TATO 03

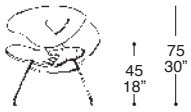
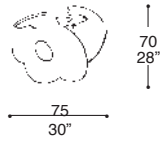

TATO 04 "A"

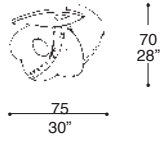

37 ►



TATO 05 "B"

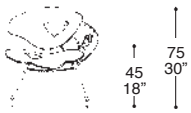
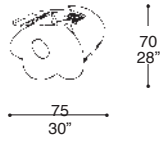

TATO 06 "C"

