

ROD 05 "A"

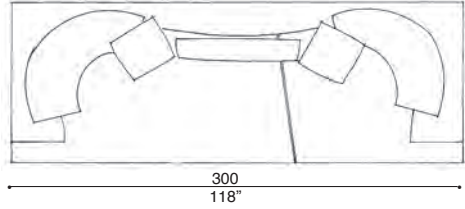

ROD 06 "B"

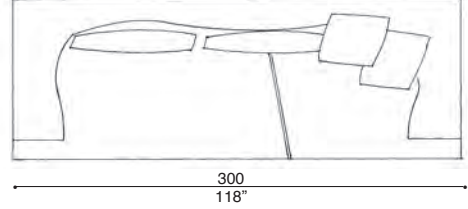

ROD 04 "C"

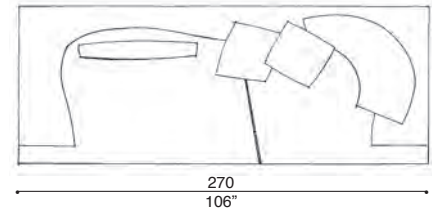

ROD 61 "D"

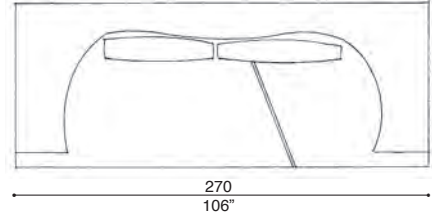

ROD 62 "E"

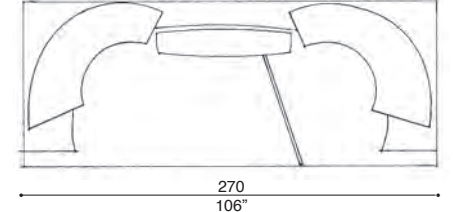

ROD 03

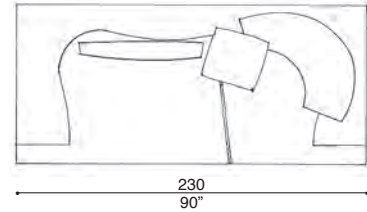

ROD 02

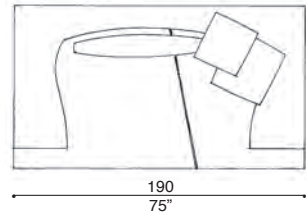

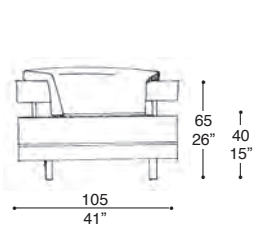

ROD 01

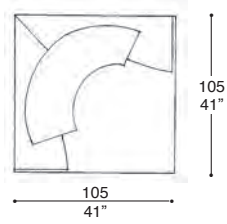

ROD 15

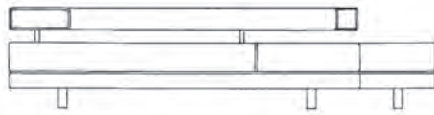
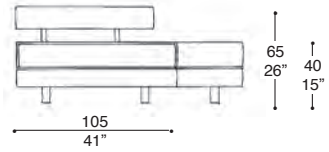
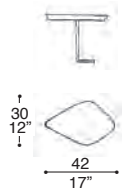

ROD 09

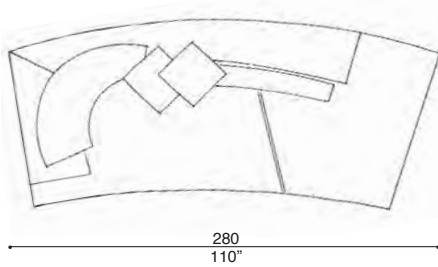

ROD 10

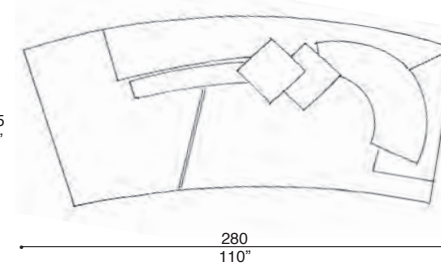

3 ▶

ROD 07

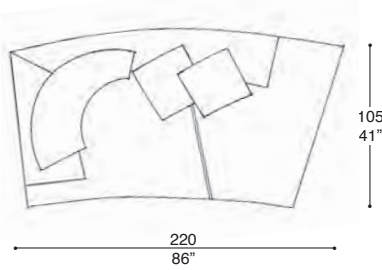

ROD 08

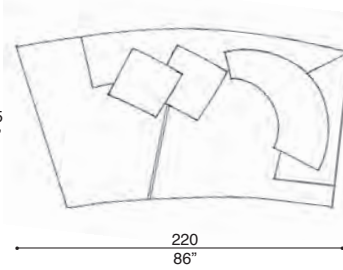

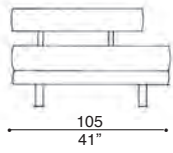

65
26"
40
15"



ROD 22

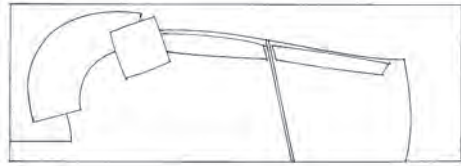

300
118"

ROD 23

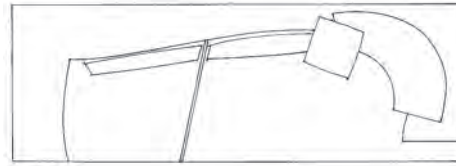

300
118"

ROD 20

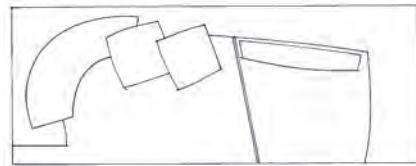

270
106"

ROD 21

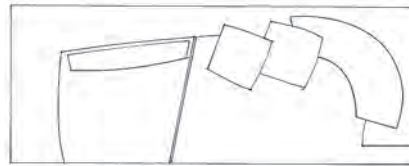

270
106"

5 ▶

ROD 18

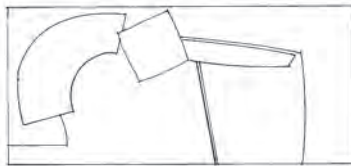

230
90"

ROD 19

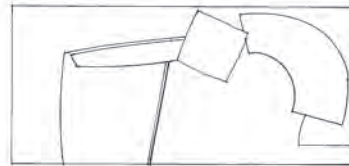

230
90"

ROD 16

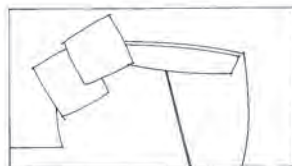

190
75"

ROD 17

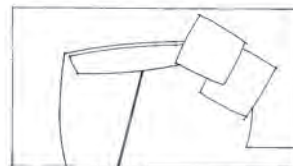

190
75"

ROD 38

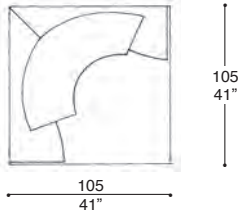

ROD 28

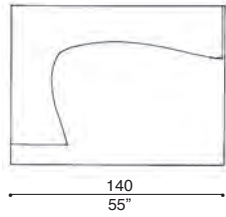

ROD 29

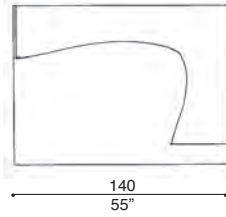

ROD 36

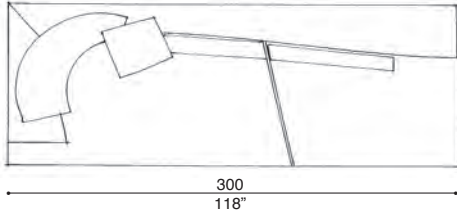

ROD 37

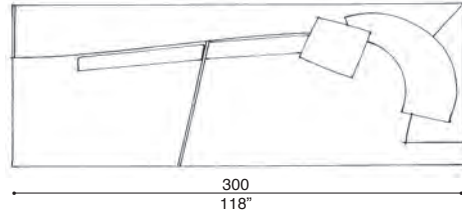

ROD 34

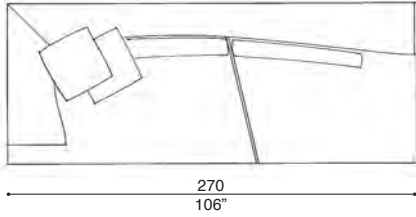

ROD 35

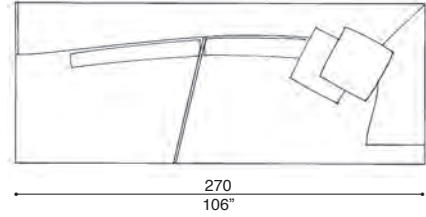

7 ▶

ROD 32

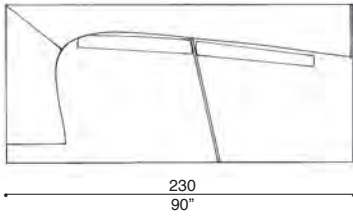

ROD 33

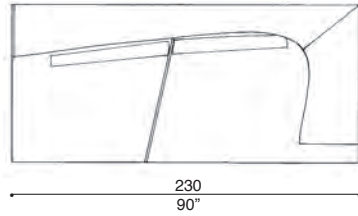

ROD 30

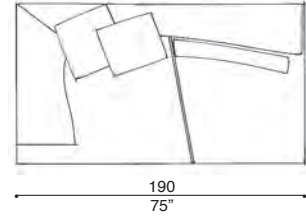

ROD 31

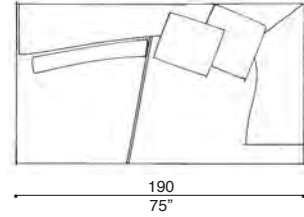

ROD 11

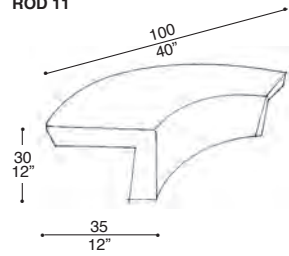

ROD 12

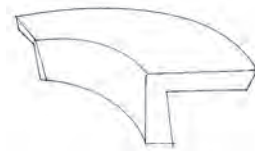

ROD 13

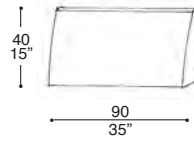

ROD 14

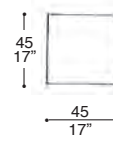

ROD 57

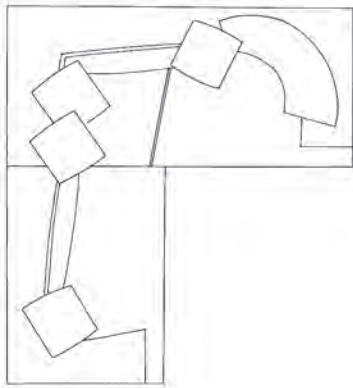

ROD 58

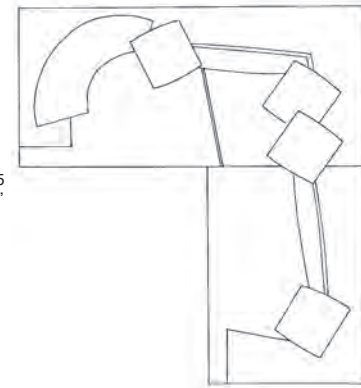

ROD 59

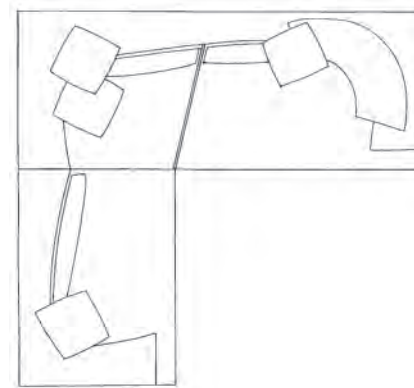

ROD 60

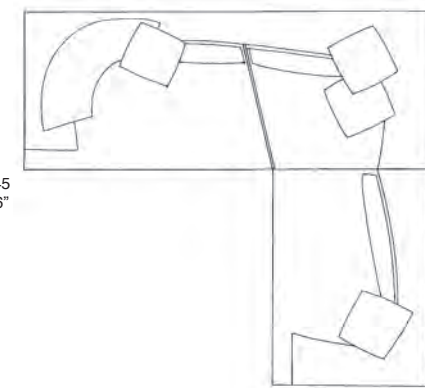

9 ▶

ROD 27

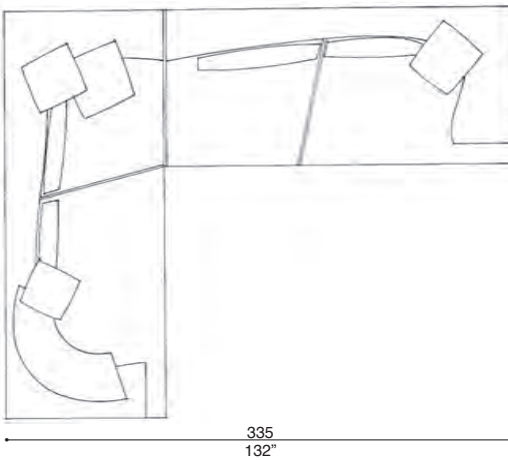

ROD 26

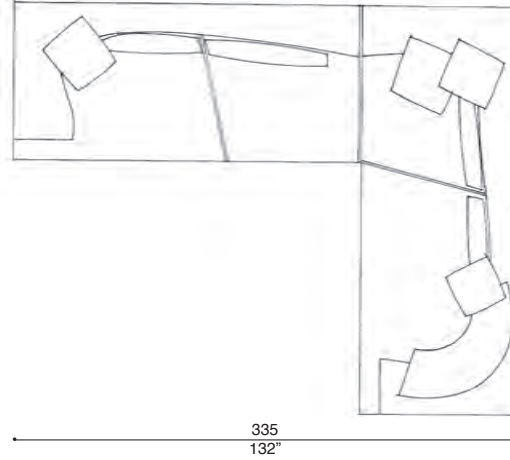

ROD 63

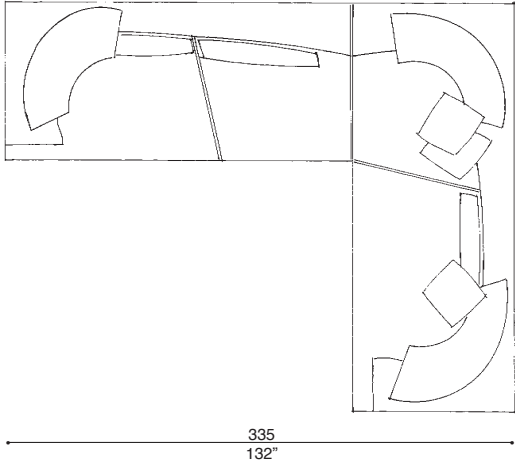

ROD 64

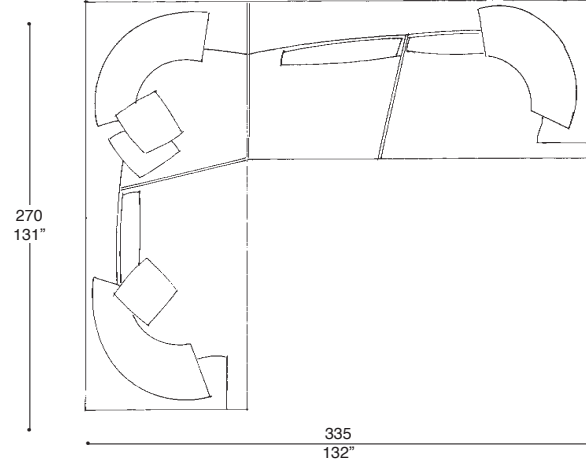

11 ►

ROD 24

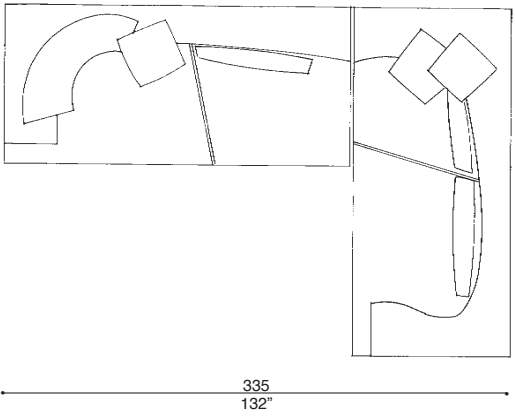

ROD 25

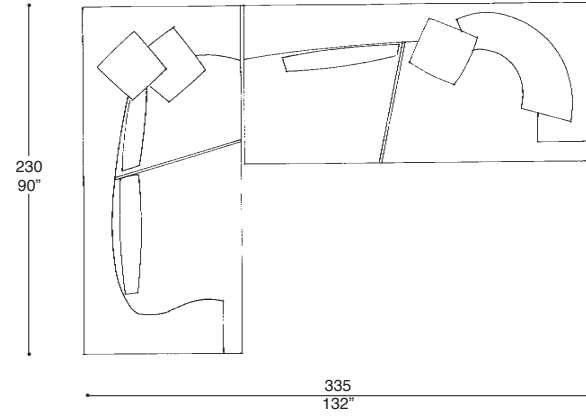

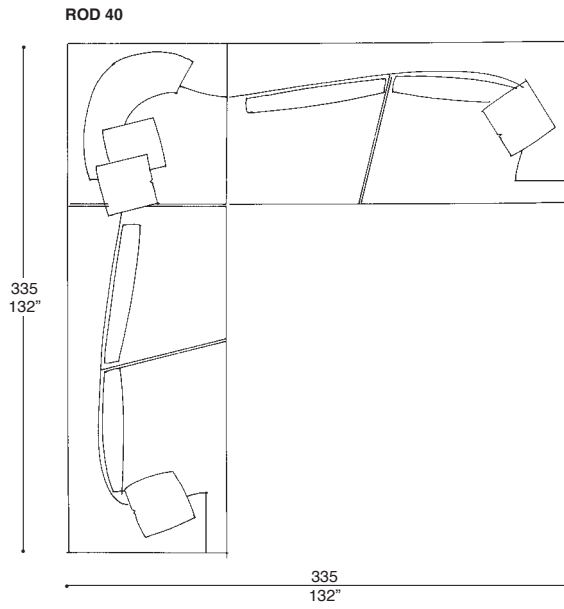
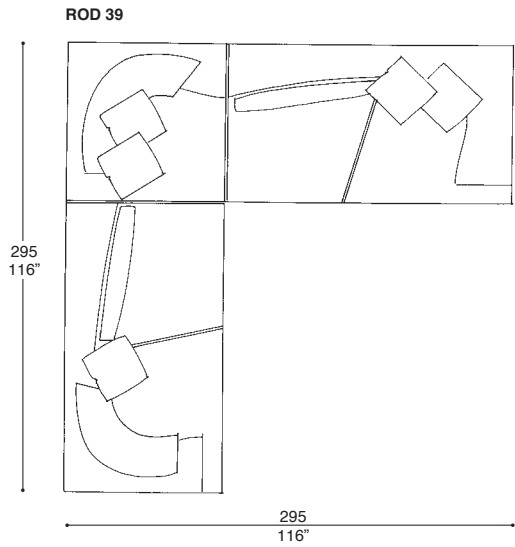

13 ▶

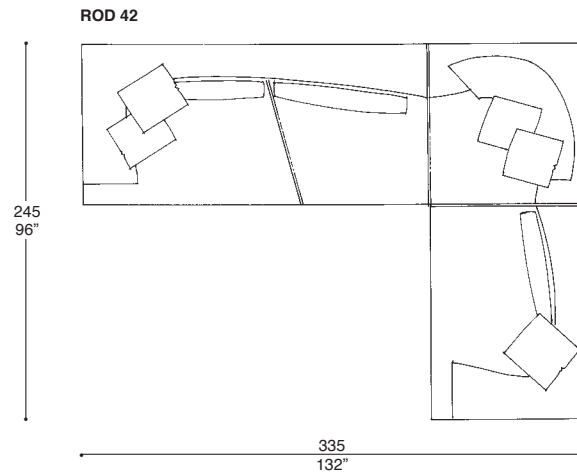
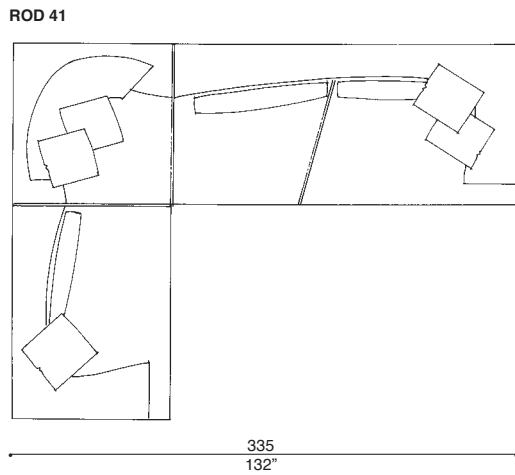

ROD 43

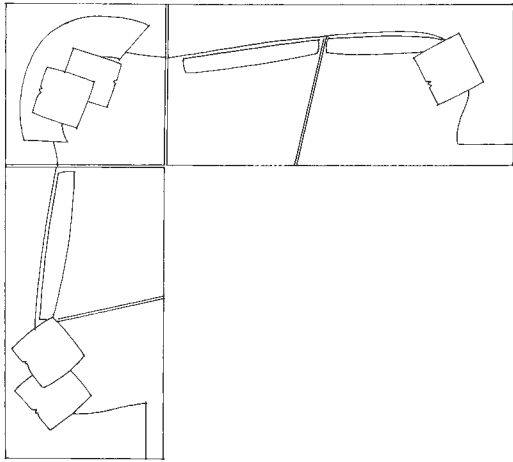

335
132"

ROD 44

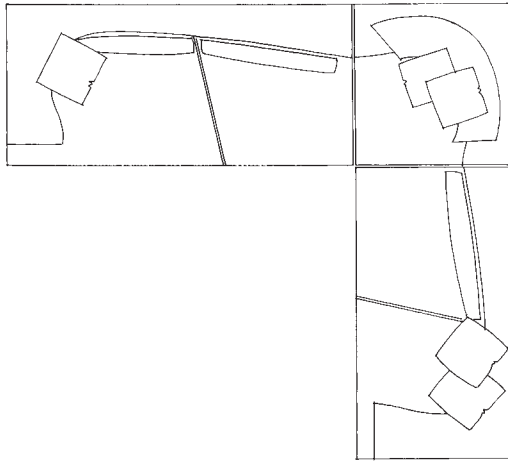

335
132"

295
116"

15 ▶

ROD 45

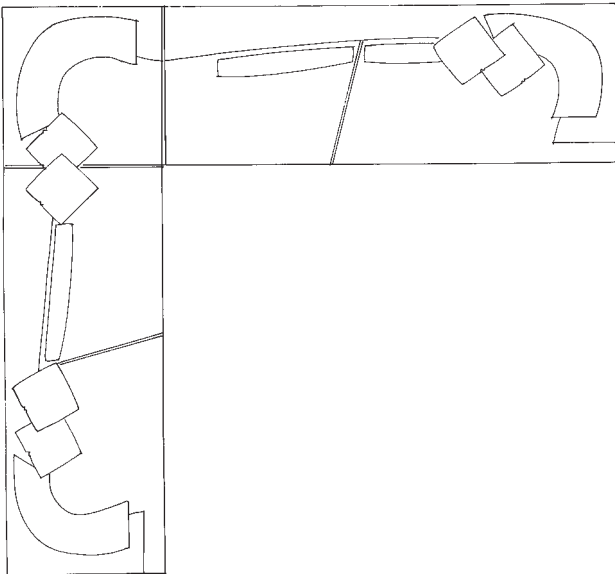

405
159"

ROD 46

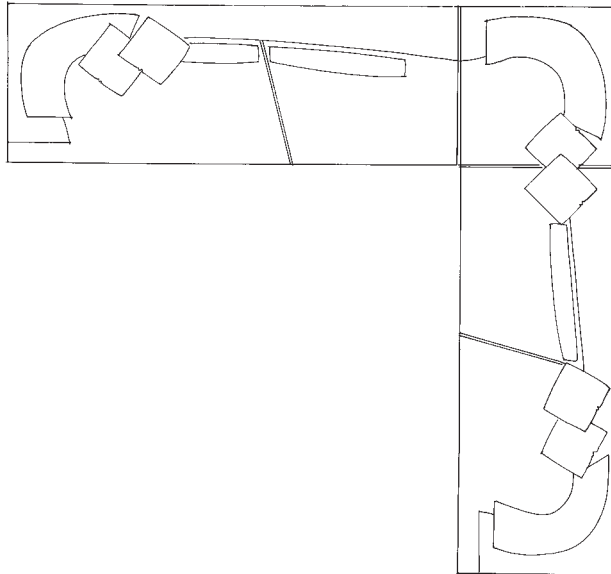

405
159"

375
148"

ROD 51

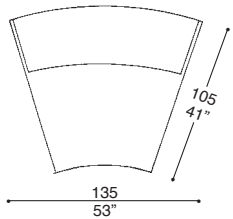

ROD 47

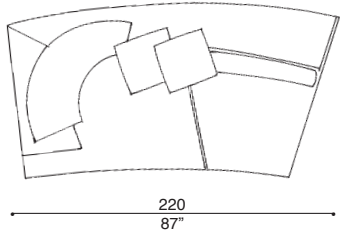

ROD 48

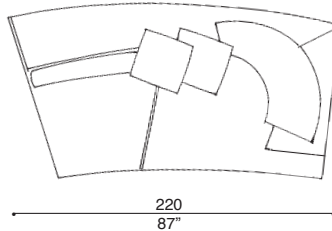

ROD 49

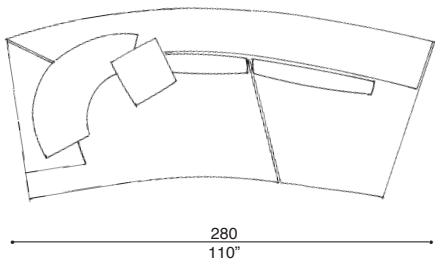

ROD 50

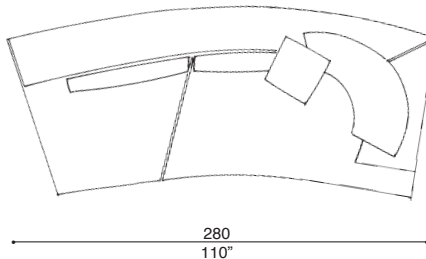

ROD 52

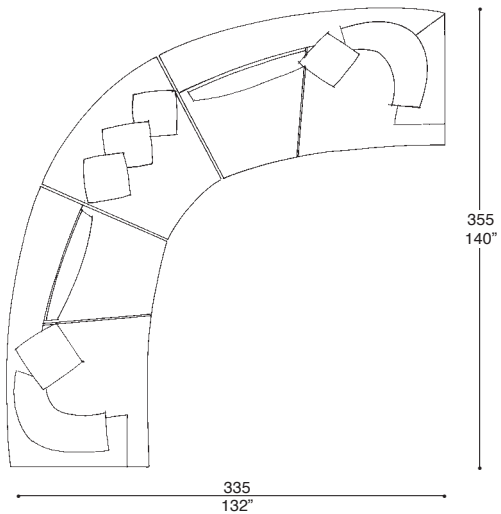

ROD 53

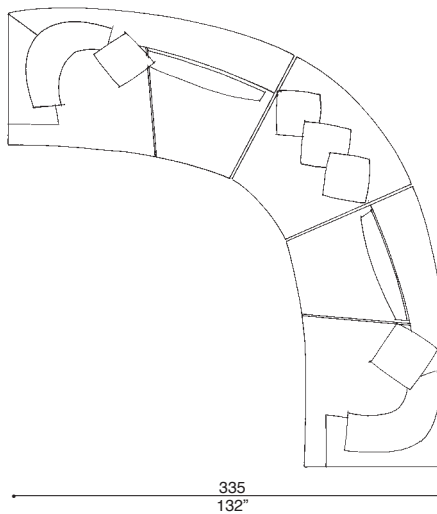

ROD 54

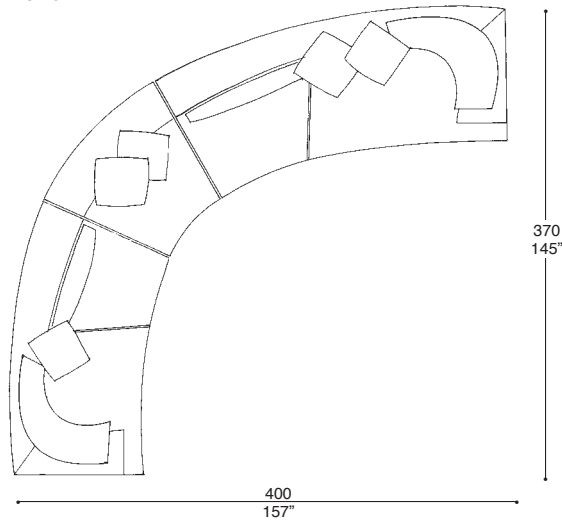

ROD 55

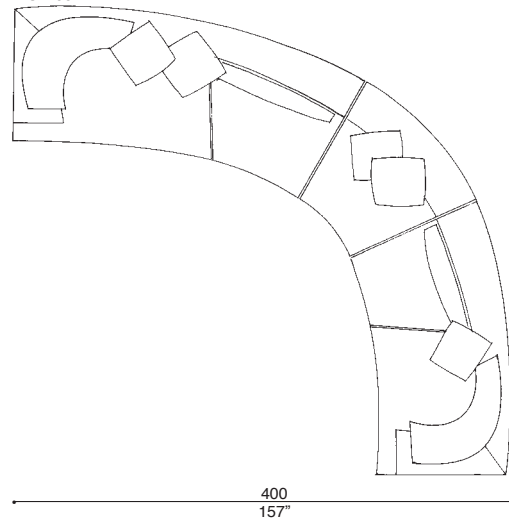

19 ▶

ROD 56

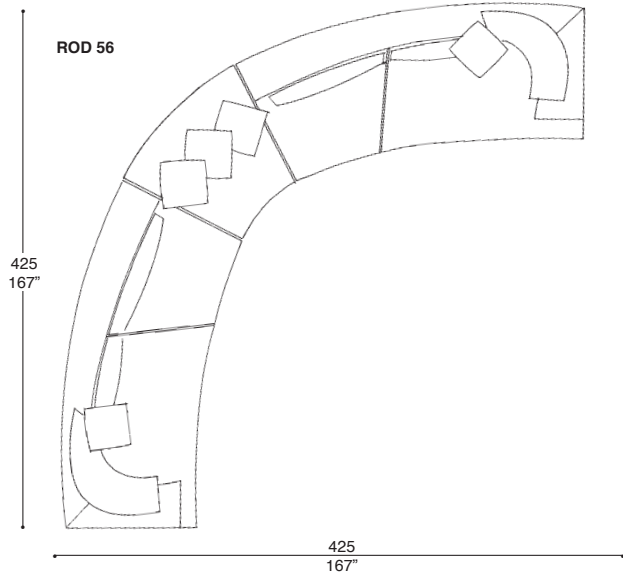

ROD 65

