

# creating green spaces

CATALOGUE 2019

hobbyflower®



# Índice Index

- 5 Introducción | Introduction
- 6 Diseñadores | Designers
- 8 Sistema Hobby Flower | Hobby Flower System
- 9 Instrucciones de plantado | Planting Instructions
- 10 Novedades | New collections

## COLECCIONES COLLECTIONS

- 14 Ashi
- 18 Zen
- 20 Top
- 22 Cut
- 26 Urban
- 28 Urban Light
- 30 Kai
- 32 Boira
- 34 City Plus
- 36 Steel
- 38 Steel Plus
- 40 Cosmo
- 44 Arc
- 46 Natura
- 48 Roma
- 50 Forest
- 52 Cuir
- 54 Desideri
- 56 London
- 60 Basic
- 62 Basic Plus
- 64 City
- 66 Novo
- 68 Ice
- 70 Ice Light
- 72 Adel
- 73 Lina

## SERVICIOS SERVICES

- 74 Hobby Green
- 75 Hobby Plus

## MATERIALES Y ACABADOS MATERIALS & FINISHES

## COMPLEMENTOS ACCESSORIES

## PROPIEDADES FEATURES



**Luz**  
Light



**Exterior**  
Outdoor



**Requiere corriente eléctrica**  
Electric current required



## creating green spaces

La única Hidrojardinera dotada de un exclusivo sistema patentado de autorriego que reproduce fielmente el entorno natural de las plantas.

Nuestra historia se remonta a 1974, cuando junto a la Universidad de Biología de Barcelona se desarrolló y patentó el sistema Hobby Flower. Desde nuestros inicios hemos apostado por crear espacios verdes adaptados a todo tipo de entornos uniendo calidad, diseño y ecología.

The unique Hydroplanter with an exclusive selfwatering patented system that recreates the natural environment of plants.

Our history goes back to 1974, when together with the University of Biology of Barcelona we developed and patented the Hobby Flower system. From our beginnings we promoted to create green spaces suitable for all kinds of environments joining quality, design and ecology.

Welcome to Hobby Flower.

# Diseñadores Designers



## Emiliana Design Studio

Ana Mir y Emili Padrós, autores de la colección Ashi, son conocidos mundialmente por sus diseños creativos caracterizados por favorecer un enfoque transversal en la disciplina del diseño.

Ana Mir and Emili Padrós, designers of Ashi collection, are worldwide known for their creative designs characterized by a transversal approach in the discipline of design.



## Jordi Vilardell

Diseñador catalán desde 1983 especialista en proyectos para iluminación decorativa y técnica con una larga trayectoria en el sector del Contract.

Catalan designer, specialist in technical and decorative illumination projects for the Contract market since 1983.



## Josep Llusçà

Diseñador Industrial y creador de la colección Novo. Desde 1972 ha colaborado con prestigiosas empresas internacionales en todo tipo de áreas industriales.

Industrial Designer, he was the designer of Novo collection. Since 1972 he has collaborated with prestigious international companies in all kinds of industrial areas.



## Meritxell Vidal

Interiorista y diseñadora industrial, ha colaborado con Jordi Vilardell para desarrollar las colecciones Adel y Lina, llevando a cabo un exhaustivo estudio sobre las necesidades de las orquídeas.

Interior and industrial designer, she has collaborated with Jordi Vilardell to develop the collections Adel and Lina, carrying out an exhaustive study on the needs of the orchids.



## Fabricación nacional National manufacturing

En Hobby Flower trabajamos y promovemos la fabricación nacional. De la mano de prestigiosos diseñadores, cuidamos nuestros diseños, su durabilidad y la extensa gama de acabados con la que contamos. Ofrecemos calidad unida a la proximidad.

In Hobby Flower we work and promote a national manufacture. Together with prestigious designers, we take care of our designs, it's durability and the wide range of finishes that we have. We offer quality together with proximity.



## Procesos artesanales Handmade processes

Siguiendo nuestra filosofía, en Hobby Flower fabricamos todos los productos mediante procesos manuales y artesanales con la finalidad de conseguir la máxima calidad en los acabados y materiales.

Following our philosophy, in Hobby Flower we manufacture all the products through manual and craft processes to achieve the highest quality in finishes and materials.



# Una forma más fácil de cuidar tus plantas

An easier way to take care of your plants

## Patented System®

Sistema de autorriego patentado con espíritu ecológico. Llenar el depósito solo 4 veces al año y regar superficialmente cada 4 o 5 semanas.

¿El resultado? Plantas perfectas con el mínimo mantenimiento.

Self-watering patented system with ecological spirit. Fill the tank only 4 times a year and water it superficially every 4 or 5 weeks.

The result? Perfect plants with minimum maintenance.



## Instrucciones de plantado Planting instructions

1

### Coloque el drenaje

Spread the drainage

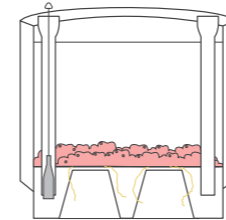

Esparza uniformemente el material de drenaje por encima de las mechas hasta un grueso aproximado de 2 centímetros.

Spread the drainage material uniformly on top of the wicks until they are covered by a layer of approximately 2 centimetres.

2

### Añada el sustrato

Add the soil layer

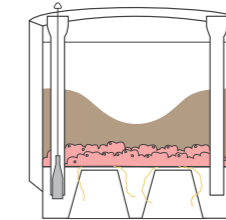

Añada sustrato sobre el drenaje dejando un agujero para cada planta que quiera plantar en su Hidrojardinera. Utilice el sustrato adecuado al tipo de planta deseado.

Cover the drainage layer with soil, leaving a hole for each plant that you wish to plant in your Hydroplanter. Use the appropriate soil for the desired plant.

3

### Colocar la planta

Place the plant

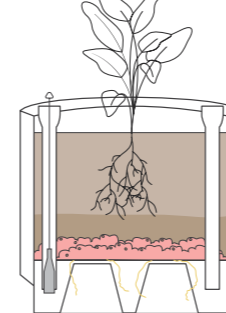

Antes de plantar la planta le recomendamos que las raíces queden un poco sueltas (procurando que no se rompan) para favorecer su crecimiento en el sustrato.

Before planting the plant in its corresponding hole we recommend that you loosen the roots (without breaking them) which will encourage the plants to take root in the new soil.

4

### Regar el sustrato

Water the soil

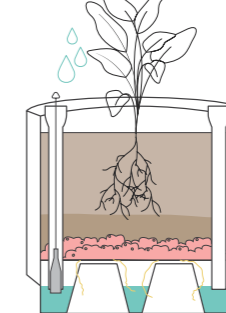

Después de realizar el PRIMER plantado, regar el sustrato lentamente, a fin de empapar la tierra y el drenaje y llenar el depósito. La varilla indicadora mostrará el nivel máximo del agua.

After planting the FIRST time, it is important to water the soil slowly until the soil and drainage layer is moist and the water tank is full. The indicator rod will show the maximum water level.

# Ahorra hasta un 80% de agua

Save up to 80% of irrigation water

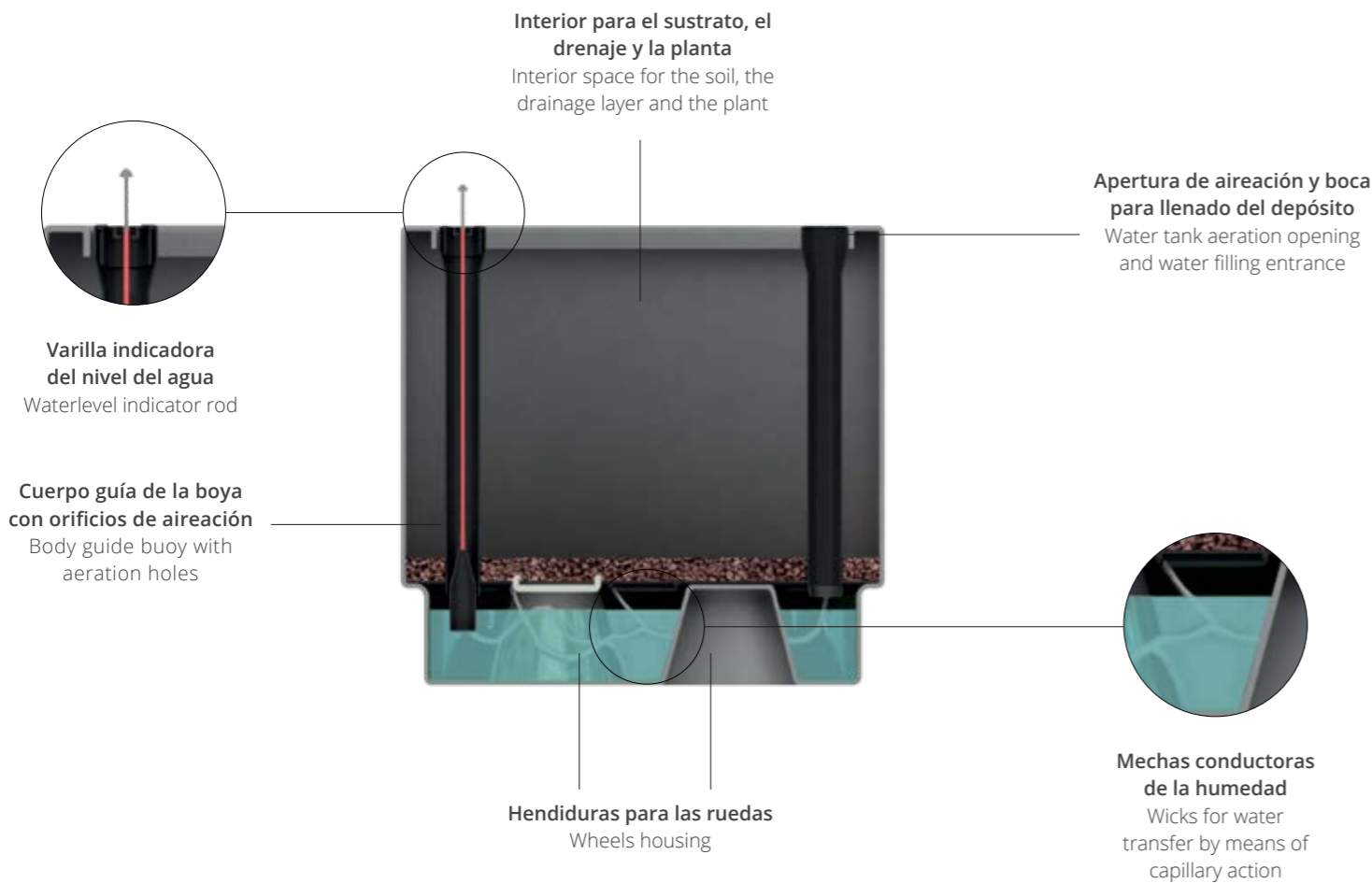

Sistema patentado certificado por la Universidad de Biología Barcelona - UB  
Patented system certified by the University of Biology of Barcelona.

# Novedades

## New collections

by our designers

Nuevas colecciones basadas en las últimas tendencias en decoración y diseño.

New collections based on latest trends in decoration and design.





Stunning sophistication.  
Collections that inspire  
design and minimalism.

DESIGN COLLECTION







“  
*Su geometría y proporción nos permite componer pequeñas islas de vegetación y descanso. Its geometry and proportion allow us to compose small islands of vegetation and rest.*

- Emiliana Design Studio

**HIDROJARDINERAS**  
 HYDROPLANTER:

- WHITE | BLANCO
- TAUPE
- LEAD | PLOMO
- BORDEAUX

**Madera fresno natural**  
**Acero inoxidable lacado**  
 Natural ash wood  
 Stainless steel lacquered

**PUFOS**  
 POUF:

- BEIGE P10
- GREY | GRIS CLARO P20
- ROSÉ P30
- BORDEAUX P40

**Madera fresno natural**  
**Tapizado en tejido con tratamiento FR**  
 Natural ash wood  
 Upholstered in fabric with FR treatment

**MESAS | TABLES:**

**Madera fresno natural**  
 Natural ash wood

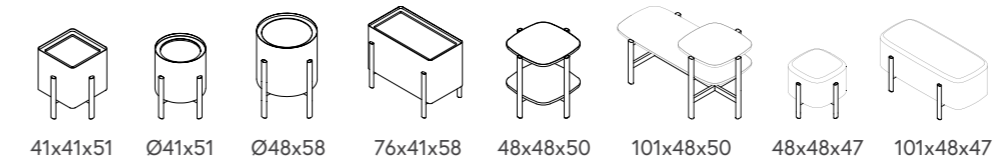



“

*Nos transporta a la sofisticación gracias a la pureza de sus líneas. It moves us to sophistication thanks to the purity of its lines.*

- Jordi Vilardell

WHITE | BLANCO

LEAD | PLOMO

CORTEN

Acero Inoxidable Esmaltado  
Enamelled Stainless Steel

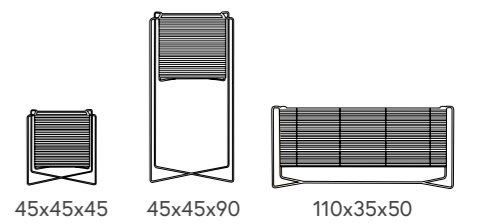



“

*Su encanto refinado y fresco le da a los espacios un carácter único.*

*Its refined and fresh charm gives the spaces a unique personality.*

- Jordi Vilardell

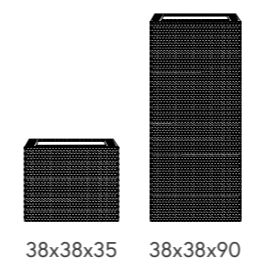

- WHITE | BLANCO
- LEAD | PLOMO
- CORTEN

Acero Inoxidable Férnico Esmaltado  
Enamelled Ferric Stainless Steel



**Cut** | Design Collection

design by Jordi Vilardell



“

*Proyecta la elegancia del metal en todo tipo de entornos. Puro diseño.  
Projects the elegance of metal in all kinds of environments. Purely design.*

- Jordi Vilardell

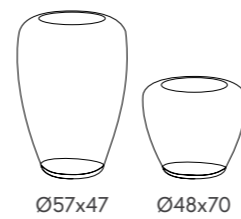

Ø57x47

Ø48x70

INOX MATT

Acero Inoxidable mate  
Matt Stainless Steel  
AISI 304



New collections  
based on the latest  
trends in decoration  
and design.

METAL COLLECTION



# Urban | Metal Collection

design by Hobby Flower



“  
*Tratada para resistir a la intemperie, es la pieza perfecta para los ambientes urbanos.*  
*Specially treated to withstand outdoors, it becomes the perfect collection for urban environments.*  
 - Hobby Flower

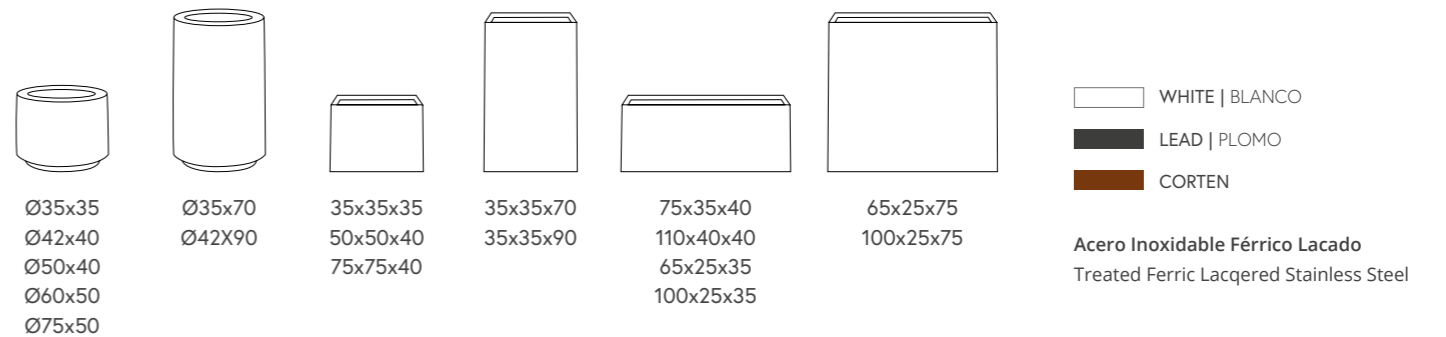

# Urban Light | Metal Collection

design by Jordi Vilardell



“  
*Plantas e iluminación  
unidas para perfeccionar  
los espacios decorativos.  
Lighting and plants to  
perfect decorative spaces.*

- Jordi Vilardell

- WHITE | BLANCO 
- LEAD | PLOMO 
- CORTEN 

Acero Inoxidable Férrico Lacado  
LED de 8W a 24V, blanco neutro  
Treated Ferric Lacquered Stainless Steel  
LED from 8W to 24V, neutral white

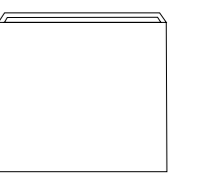

100x25x75

# Kai | Metal Collection

design by Jordi Vilardell

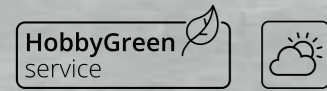

“  
*Delimitar espacios con plantas con elegancia y funcionalidad  
To divide spaces with plants, gives elegance and functionality.*

- Jordi Vilardell

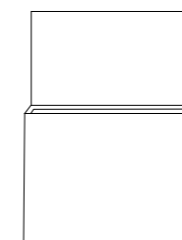

100x25x135

- WHITE | BLANCO
- LEAD | PLOMO
- CORTEN

Acero Inoxidable Férrico con cristal (PVB)  
Ferric Stainless Steel with glass (PVB)



# Boira | Metal Collection

design by Kriskadecor & Hobby Flower



“

*Una solución de diseño única para decorar tus espacios.  
A unique design solution to decorate your spaces.*

- Kriskadecor & Hobby Flower

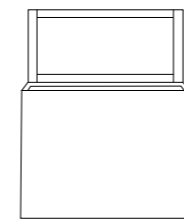

100x25x135

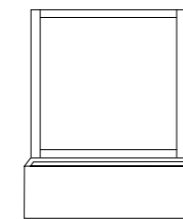

110x40x135

- WHITE | BLANCO
- LEAD | PLOMO
- CORTEN

Jardinera de Acero Inoxidable Férrico con separador de cadena de aluminio anodizado  
Ferric Stainless Steel planter with anodized aluminum chain divider

\* Consultar para colores resistentes a exterior  
\* Consult for outdoor resistant colors

CADENA | CHAIN



COLORES LISOS | PLAIN COLORS

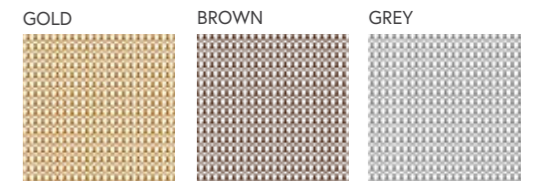

DEGRADÉ | GRADIENTS

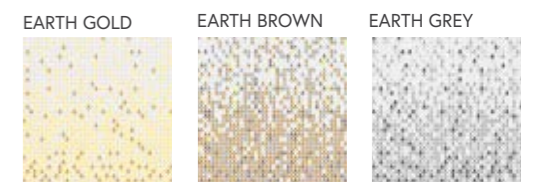

# City Plus | Metal Collection

design by Hobby Flower



“

*La pieza de gran capacidad perfecta para las plantas más majestuosas.*

*The perfect model with big internal capacity for the most majestic plants.*

- Hobby Flower

WHITE | BLANCO

LEAD | PLOMO

CORTEN

Acero Inoxidable Férrico Lacado  
Ferric Lacquered Stainless Steel

\*Con refuerzos interiores

\* With internal reinforcement

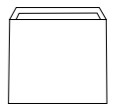

60x60x60

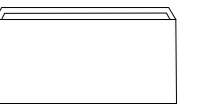

120x40x60





- INOX MATT | MATE
- INOX SHINY | BRILLANTE

Acero Inoxidable  
Stainless Steel  
AISI 304

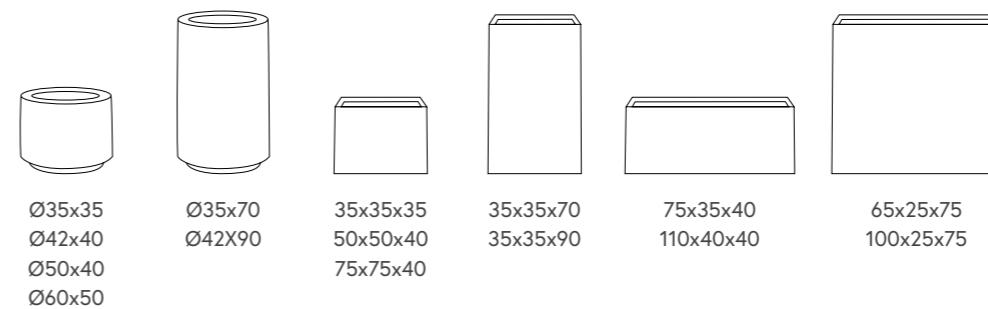

# Steel Plus | Metal Collection

design by Hobby Flower

HobbyGreen  
service

choose your  
color  
**HOBBY  
PLUS**  
+  
Customize  
with your  
brand



- WHITE | BLANCO
- BLACK | NEGRO
- RED | ROJO
- BROWN | CHOCOLATE
- ANTHRACITE | ANTRACITA

Acero Inoxidable Férrico Lacado Brillo  
Glossy Lacquered Ferric Stainless Steel

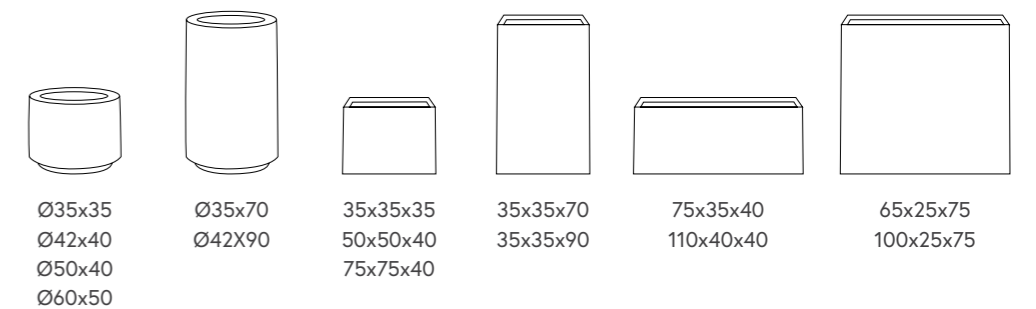

# Cosmo | Metal Collection

design by Hobby Flower



“

*Edición limitada de elegante metal es la protagonista en cualquier ambiente.*

*Limited edition of elegant metal is the star of any space.*

- Hobby Flower

INOX MATT

Acero Inoxidable  
Stainless Steel  
AISI 304

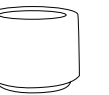

Ø 54x40  
Ø 65x50



Universe of warm  
and clean lines. Designs  
that connect us with  
noble materials.

WOOD COLLECTION

# Arc | Wood Collection

design by Jordi Vilardell

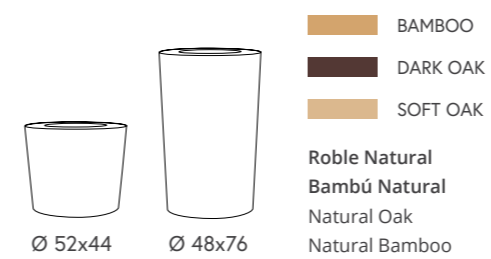

“

*Llena los espacios de naturaleza gracias a su cálida presencia.  
Fill the spaces of nature thanks to its warm presence.*

- Jordi Vilardell

# Natura | Wood Collection

design by Jordi Vilardell



“

*Universo de líneas cálidas y limpias fusionadas con acabados actuales.*

*Universe of warm and clean lines fusioned with actual surface finishes.*

- Jordi Vilardell

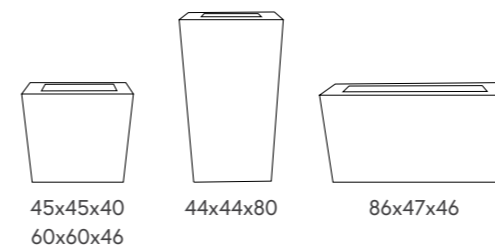

- DARK OAK
- MEDIUM OAK
- SOFT OAK

Roble Natural  
Natural Oak





# Roma | Wood Collection

design by Jordi Vilardell



“

*Rompe con las figuras lineales ofreciendo acabados inigualables en roble.*

*Roma breaks with linear figures offering unparalleled finishes in oak.*

- Jordi Vilardell

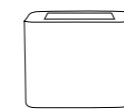

40x40x35



40x40x85

DARK OAK

SOFT OAK

Roble Natural  
Natural Oak



# Forest | Wood Collection

design by Jordi Vilardell



“

*Su acabado en madera tratada es la pieza idónea para ambientes exteriores.*

*Its finish in treated wood makes it become the perfect collection for outdoor spaces.*

- Jordi Vilardell

TROPICAL 

OLD GREY 

Abeto Douglas Tratado  
Treated Douglas Fir

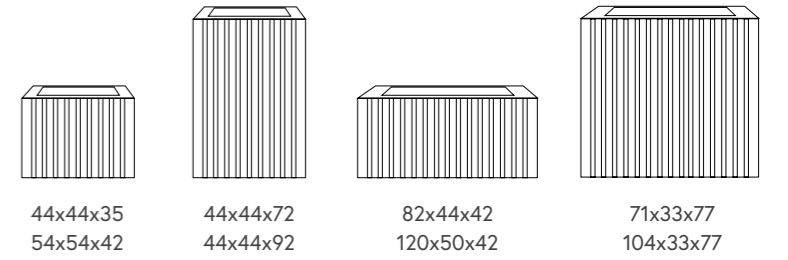

Cuir | Wood Collection

design by Hobby Flower



“

*Elegante y burguesa, combina madera y piel natural en perfecta simbiosis.  
Elegant and bourgeois, it combines wood and natural leather in a perfect harmony.*

- Hobby Flower

PIEL | LEATHER 

Madera de Roble y cuero Okawango  
Oak Wood and Okawango leather

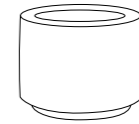

Ø 53x42

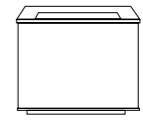

54x54x42

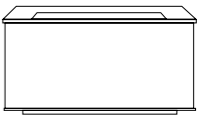

78x40x42



# Desideri | Wood Collection

design by Hobby Flower



“

*Realizada con materiales nobles y de manera artesanal, imprescindible en un ambientes clásicos y modernos. Made with the finest materials and handcrafted, essential in a classical environment or a modern setting.*

- Hobby Flower

Madera de cerezo  
Cherry-tree wood

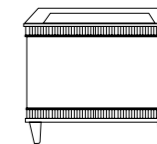

53x53x50

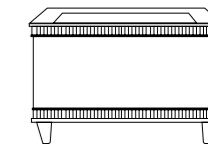

78x39x50





MARQUETERÍA INGLESA  
ENGLISH MARQUETRY

Madera de Caoba, Palorosa, Arce y Palisandro  
Caoba, Rosewood, Palo Rosa and Maple woods

“

*Piezas únicas y sofisticadas pensadas especialmente para los espacios más selectos. Unique and sophisticated pieces, especially designed for the finest spaces.*

- Hobby Flower

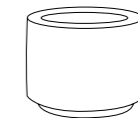

Ø 54x43

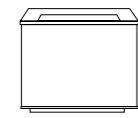

53x53x40

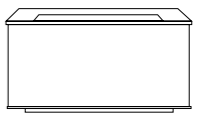

78x39x40

Colors and  
brightness in its  
boldest version.

PLASTIC COLLECTION



# Basic | Plastic Collection

design by Hobby Flower

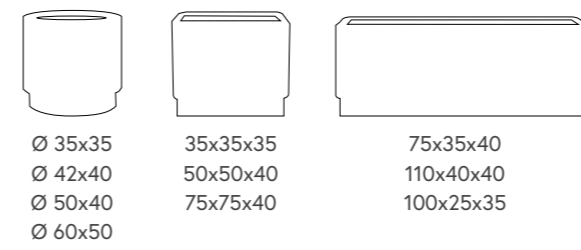

- WHITE | BLANCO
- ANTHRACITE | ANTRACITA
- BROWN | CHOCOLATE
- OXID
- BLACK | NEGRO
- TAUPE
- RED | ROJO

Polietileno por rotomoldeo  
Rotomolding Polyethylene

# Basic Plus | Plastic Collection

design by Hobby Flower

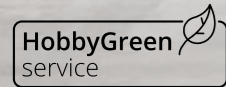

GREEN LIME | VERDE LIMA 

ORANGE | NARANJA 

AUBERGINE | BERENJENA 

Polietileno por rotomoldeo

Acabado brillante

Rotomolding Polyethylene

Bright finish

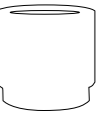

Ø 42x40

Ø 50x40





# City | Plastic Collection



design by Hobby Flower



“

*Destaca por su funcionalidad y una resistencia única a adversidades meteorológicas.  
Stands out for its functionality and unique resistance to meteorological adversity.*

- Hobby Flower

-  ANTHRACITE | ANTRACITA
-  OXID

Polietileno por rotomoldeo  
Rotomolding Polyethylene

\*Con refuerzos interiores  
\* With internal reinforcement

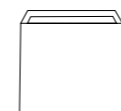

60x60x60



120x40x60



# Novo | Plastic Collection

design by Josep Lluscà



Ø 42x39  
Ø 52x43  
Ø 62x53



Ø 42x75

- COBALT | COBALTO
- WHITE | BLANCO
- ANTHRACITE | ANTRACITA
- RED | ROJO
- OXID

Polietileno por rotomoldeo  
Rotomolding Polyethylene

“  
Colección de versatilidad perfecta  
capaz de adaptarse a cualquier entorno.  
Collection with a perfect versatility to  
suit any functional localization.

- Josep Lluscà

# Ice | Plastic Collection

design by Jordi Vilardell

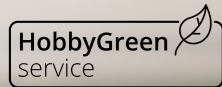

“

*Pensada para convertir cada creación en un objeto especial llenando los espacios de matizadas tonalidades.*

*Designed to make of each creation a special object filling the spaces of nuanced hues.*

- Jordi Vilardell

WHITE   BLANCO	
ANTHRACITE   ANTRACITA	
BROWN   CHOCOLATE	
OXID	
BLACK   NEGRO	
TAUPE	
RED   ROJO	
GREEN LIME   VERDE LIMA	
ORANGE   NARANJA	
AUBERGINE   BERENJENA	

Cubierta HIPS/PMMA  
HIPS/PMMA Cover

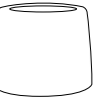

Ø 54x40



# Ice Light | Plastic Collection

design by Jordi Vilardell



“

*Ilumina con diferentes combinaciones de suave color a través de su cubierta translúcida.*

*Illuminates with different combinations of soft color through its translucent cover.*

- Jordi Vilardell

WHITE | BLANCO 

BLACK | NEGRO 

RED | ROJO 

BROWN | CHOCOLATE 

TAUPE 

ANTHRACITE | ANTRACITA 

OXID 

LIME GREEN | VERDE LIMA 

ORANGE | NARANJA 

AUBERGINE | BERENJENA 

Cubierta HIPS/PMMA 

Línea de LED Blanco Puro

HIPS/PMMA Cover

Pure White LED Line

Ø 54x40

# Adel | Plastic Collection

design by Jordi Vilardell & Meritxell Vidal



# Lina | Plastic Collection

design by Jordi Vilardell & Meritxell Vidal



Ø 20x20

PCTA/ABS  
Pieces PCTA/ABS

TRANSPARENT | TRANSPARENTE

WHITE | BLANCO

BLACK | NEGRO

AUBERGINE | BERENJENA

TRANSLUCID COLORS | COLORES TRANSLÚCIDOS:

FUMÉ

CYAN

WINE | VINO

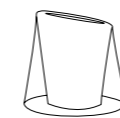

Ø 20x20

TRANSPARENT

FUCHSIA

LILAC

PCTA/ABS  
Pieces PCTA/ABS



# Hobby Green



# Hobby Plus

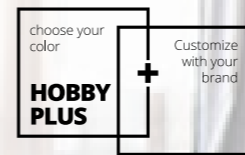

## Aire puro en interiores, espacios más saludables

Pure air indoors, healthier spaces.

Te ofrecemos un servicio integral y personalizado de decoración para tu empresa, con hidro jardineras y plantas naturales de Hobby Flower.

We offer a complete decoration customized service for companies, with Hobby Flower hydroplanters and natural plants.

Trust in us



**Contacto con el equipo**  
Contact with the team

El equipo de Hobby Flower estudia tus necesidades y el espacio en el que se ubicarán las Hidrojardineras.

The team of Hobby Flower studies your needs and the space where the hydroplanters will be placed.



**Asesoramiento de plantas**  
Most suitable plants

Asesoramiento del tipo de planta más adecuada, en función de las características de cada espacio y su decoración.

Expert advice on the most suitable type of plant. Depending on the characteristics of each space and its decoration.



**Instalación**  
Installation

Instalación y colocación de las plantas en las Hidrojardineras en la localización estipulada.

Installation and placement of plants in Hydroplanters in the stipulated area.



**Servicio mantenimiento**  
Maintenance service

Mantenimiento 4 veces al año. Plantas siempre en perfectas condiciones sin preocuparse de nada.

Maintenance 4 times a year. Plants always in perfect conditions without worrying about anything.

## Personaliza tu Hidrojardinera Customize your Hydroplanter

Con Hobby Flower podrás dar un toque corporativo y exclusivo a tus proyectos personalizando las colecciones con los colores y acabados que mas se adapten a tus necesidades.

With Hobby Flower you will be able to give a corporate and exclusive touch to your projects, customizing the collections with the colors and finishes that are more suitable for your needs.

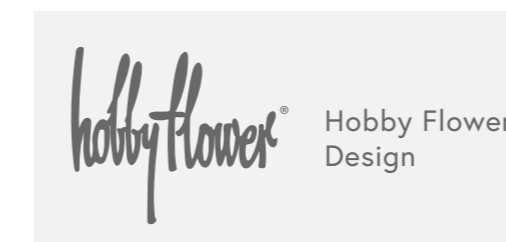

Formado por el equipo de diseñadores y especialistas de la empresa Hobby Flower se centra en el desarrollo de proyectos personalizados y nuevos diseños.

Composed by the designers and the specialists of the Hobby Flower company, it focuses on the development of customized projects and new designs.

### 1 Escoge tu jardinera\* Choose your planter\*

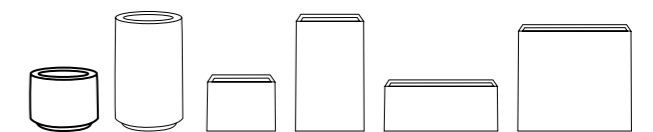

Steel Plus

### 2 Escoge tu color corporativo Choose your corporate color



### 3 Ponle el logo de tu empresa Put your company's logo



\*Consultar cantidades mínimas  
\*Consult minimum quantity



### Ashi

HIDROJARDINERAS | HYDROPLANTER:

- WHITE | BLANCO
- TAUPE
- LEAD | PLOMO
- BORDEAUX

**Patas de Madera de fresno natural curvado | Cuerpo de Acero Inoxidable Lacado Mate**

Natural Ash wooden Curved Legs  
Matte Lacquered Stainless Steel Body

MESAS | TABLES:

**Madera fresno natural macizo**  
Solid natural ash wood



PUFS | POUF:



BEIGE P10      GREY | GRIS CLARO P20



ROSÉ P30      BORDEAUX P40

**Patas de Madera fresno natural curvado Tapizado en tejido con tratamiento FR (Fire Resistant) de la marca CREVIN**  
Natural Ash wooden curved legs  
Upholstered fabric with FR treatment (Fire Resistant) of CREVIN brand

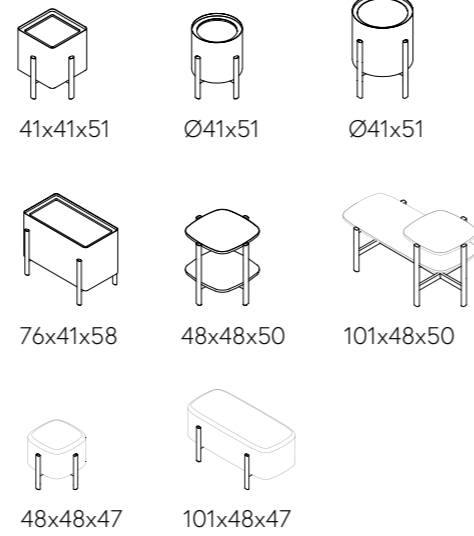

### Zen



- WHITE | BLANCO
- LEAD | PLOMO
- CORTEN

**Varilla de Acero Inoxidable Esmaltado | Tratado en cataforesis**  
Enamelled Stainless Steel Rod | Cataphoresis Treatment

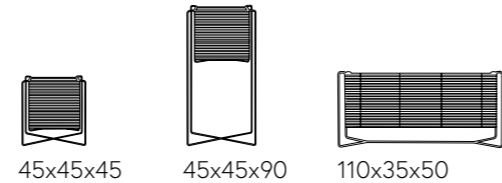

### Top



- WHITE | BLANCO
- LEAD | PLOMO
- CORTEN

**Malla de Acero Inoxidable Férrico Esmaltado**  
Enamelled Ferric Stainless Steel mesh

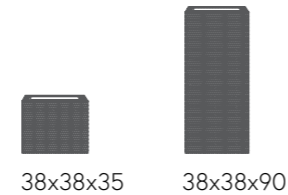

### Cut

- INOX MATT
- Acero Inoxidable mate**  
Matt Stainless Steel  
AISI 304



### Urban

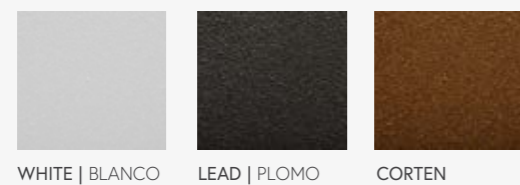

**Acero Inoxidable Férrico - Lacado mate**  
Treated Ferric Stainless Steel - Matt Lacquered  
AISI 430



### Urban

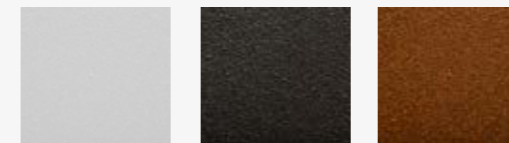

WHITE | BLANCO      LEAD | PLOMO      CORTEN

**Acero Inoxidable Férrico - Lacado mate**  
Treated Ferric Stainless Steel - Matt Lacquered  
AISI 430

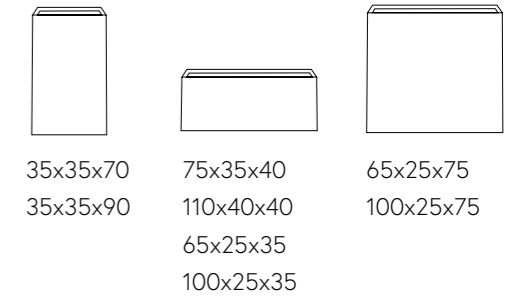

### Urban Light



- WHITE | BLANCO
- LEAD | PLOMO
- CORTEN



**Acero Inoxidable Férrico tratado - Lacado mate | AISI 430 | LED de 8W a 24V, blanco neutro | Índice protección IP 67 | Fuente alimentación 230 V**  
Treated ferric stainless steel - Matt lacquered | AISI 430 | LED from 8W to 24V, neutral white | IP 67 protection index | Power supply 230 V

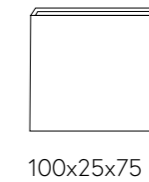

### Kai



- WHITE | BLANCO
- LEAD | PLOMO
- CORTEN

**Acero Inoxidable Férrico Lacado | AISI 430 | Doble lámina de cristal transparente de 4mm | Unida por una lámina butiral de Polivinilo (PVB) | Bordes pulidos y curvados.**  
Treated Ferric Stainless Steel | AISI 430 | Double transparent glass of 4mm. | Joined by a layer of butyral Polyvinyl (PVB) | Polished and curved edges.

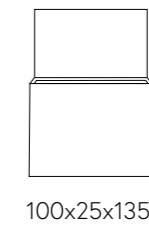

### Boira

kriskadecor®

CADENA | CHAIN



Malla: Snina  
Densidad: Estándar  
Link: Snina  
Density: Standard

- WHITE | BLANCO
- LEAD | PLOMO
- CORTEN

**Jardinería de Acero Inoxidable Férrico lacado mate | AISI 430 | Estructura de acero inoxidable férrico con cadena de aluminio anodizado de Kriskadecor**  
Matt Lacquered Ferric Stainless Steel planter | AISI 430 | Structure in ferric stainless steel with anodized aluminum chain from Kriskadecor

COLORES LISOS  
PLAIN COLORS

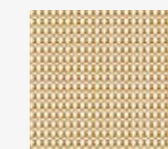

GOLD

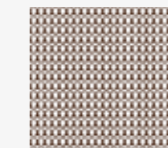

BROWN



GREY

DEGRADÉ  
GRADIENTS

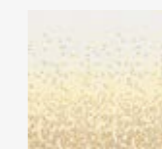

EARTH GOLD

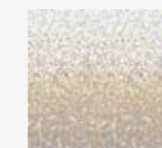

EARTH BROWN



EARTH GREY

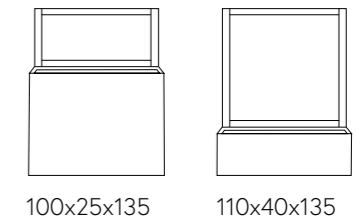

\* Consultar para colores resistentes a exterior  
\* Consult for outdoor resistant colors

## METAL COLLECTION



### City Plus



- WHITE | BLANCO
- LEAD | PLOMO
- CORTEN

**Acero Inoxidable Férrico**  
Treated Ferric Stainless Steel  
AISI 430

**Refuerzo interior con plancha de acero inoxidable contra distensiones**  
Interior reinforcement with stainless steel plate for containment against distensions

\* Hidrojardinería de gran capacidad

\* High capacity Hydroplanter

### Medidas | Measurements

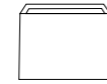

60x60x60

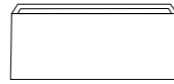

120x40x60

### Steel

- INOX MATT | MATE
- INOX SHINY | BRILLANTE

**Acero Inoxidable Férrico**  
Treated Ferric Stainless Steel  
AISI 304



Ø 35x35  
Ø 42x40  
Ø 50x40  
Ø 60x50



Ø 35x70  
Ø 42x90



35x35x35  
50x50x40  
75x75x40

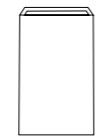

35x35x70  
35x35x90

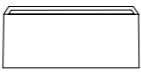

75x35x40  
110x40x40

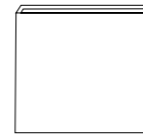

65x25x75  
100x25x75

### Steel Plus

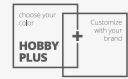

- WHITE | BLANCO
- BLACK | NEGRO
- RED | ROJO
- BROWN | CHOCOLATE
- ANTHRACITE | ANTRACITA

**Acero inoxidable Férrico Lacado Brillo**  
Glossy Lacquered Ferric Stainless Steel  
AISI 430

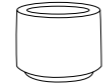

Ø 35x35  
Ø 42x40  
Ø 50x40  
Ø 60x50

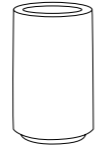

Ø 35x70  
Ø 42x90

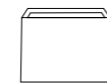

35x35x35  
50x50x40  
75x75x40



35x35x70  
35x35x90



75x35x40  
110x40x40

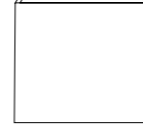

65x25x75  
100x25x75

### Cosmo

- INOX MATT

**Acero Inoxidable mate**  
Matt Stainless Steel  
AISI 304



Ø 54x40  
Ø 65x50

## WOOD COLLECTION



### Arc



BAMBOO | BAMBÚ

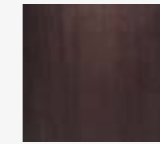

DARK OAK

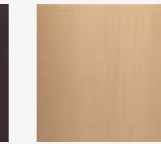

SOFT OAK

**Madera de roble natural curvada | Bambú natural**  
Natural Oak curved Wood | Natural Bamboo

### Medidas | Measurements



Ø 52x44

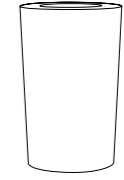

Ø 48x76

### Natura



DARK OAK



MEDIUM OAK

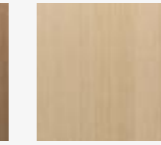

SOFT OAK

**Madera de roble natural**  
Natural Oak Wood

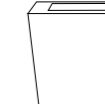

45x45x40  
60x60x46

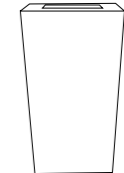

44x44x80

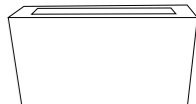

86x47x46

### Roma



DARK OAK

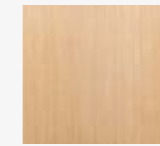

SOFT OAK

**Madera de roble natural**  
Natural Oak Wood

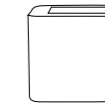

40x40x35

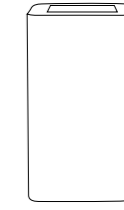

40x40x85

### Forest

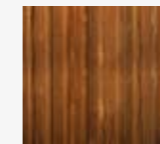

TROPICAL

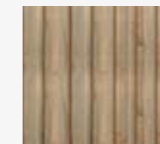

OLD GREY

**Lamas de madera natural de abeto Douglas**  
Natural Wood slats of Douglas-fir

**Certificado PEFC de gestión forestal sostenible**  
PEFC certificate for sustainable forests

**Certificado CTB B+ - tratamiento de la madera para construcción y sus aplicaciones**  
CTB B+ Certification - wood treatment for construction and fittings

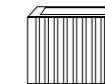

44x44x35  
54x54x42

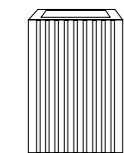

44x44x72  
44x44x92

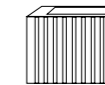

82x44x42  
120x50x42

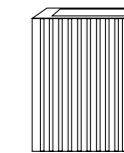

71x33x77  
104x33x77

### Cuir

- PIEL | LEATHER

**Cuero Okawango cosido sobre madera de roble natural**  
Okawango leather sewed on natural Oak Wood



Ø 53x42

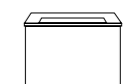

54x54x42



78x40x42



WOOD COLLECTION



Desideri

MADERA DE CEREZO | CHERRY-TREE WOOD

Madera natural de cerezo con molduras decorativas

Natural cherry-tree wood with decorative frames

Medidas | Measurements

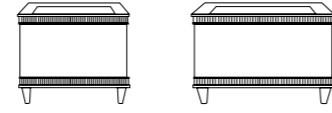

53x53x50

78x39x50

London

MARQUETERÍA INGLESA  
ENGLISH MARQUETRY

Marquetería Inglesa  
Madera natural de Caoba, Palorosa, Arce y Palisandro  
English Marquetry  
Caoba, Rosewood, Palo Rosa and Maple natural woods

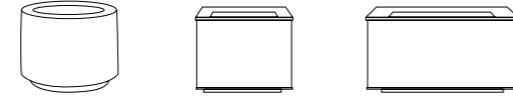

Ø 54x43

53x53x40

78x39x40

PLASTIC COLLECTION



Basic



- WHITE | BLANCO
- ANTHRACITE | ANTRACITA
- BROWN | CHOCOLATE
- OXID
- BLACK | NEGRO
- TAUPE
- RED | ROJO

Polietileno por rotomoldeo - acabado mate  
Rotomolding Polyethylene - matt finish

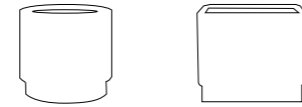

Ø 35x35

35x35x35

Ø 42x40

50x50x40

Ø 50x40

75x75x40

Ø 60x50

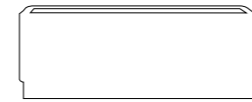

75x35x40

110x40x40

100x25x35

Basic Plus



- GREEN LIME | VERDE LIMA
- ORANGE | NARANJA
- AUBERGINE | BERENJENA

Polietileno por rotomoldeo - acabado brillo  
Rotomolding Polyethylene - glossy finish

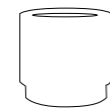

Ø 42x40

Ø 50x40

City



- ANTHRACITE | ANTRACITA
- OXID

Polietileno por rotomoldeo  
Rotomolding Polyethylene

Refuerzo interior con plancha de acero inoxidable contra distensiones.  
Interior reinforcement with stainless steel plate for containment against distensions.

\* Hidrojardinera de gran capacidad

\* High capacity Hydroplanter



60x60x60

120x40x60

PLASTIC COLLECTION



Novo



- COBALT | COBALTO
- WHITE | BLANCO
- ANTHRACITE | ANTRACITA
- RED | ROJO
- OXID

Polietileno por rotomoldeo - acabado mate  
Rotomolding Polyethylene - matt finish

Medidas | Measurements

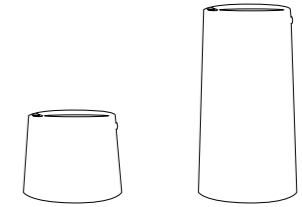

Ø 42x39

Ø 52x43

Ø 62x53

Ø 42x75

Ice



- WHITE | BLANCO
- ANTHRACITE | ANTRACITA
- BROWN | CHOCOLATE
- OXID
- BLACK | NEGRO
- TAUPE
- RED | ROJO
- GREEN LIME | VERDE LIMA
- ORANGE | NARANJA
- AUBERGINE | BERENJENA

Cubierta de plástico PETG translucido.  
PETG translucent plastic cover



Ø 54x40

Ice Light



- WHITE | BLANCO
- ANTHRACITE | ANTRACITA
- BLACK | NEGRO
- RED | ROJO
- BROWN | CHOCOLATE
- TAUPE
- OXID
- LIME GREEN | VERDE LIMA
- ORANGE | NARANJA
- AUBERGINE | BERENJENA

\* Este producto requiere fuente de electricidad.

\* This product requires power source.

Cubierta de plástico PETG translucido | Aro de acero con línea luminosa flexible de leds color blanco puro. | Voltaje Primario 220/230 V. Secundario 24 V.

PETG translucent plastic cover | Stainless Steel ring with flexible luminous line of pure white leds. | Primary potential 220/230 V. Secondary 24 V.



Ø 54x40

Adel



- TRANSPARENT | TRANSPARENTE
- WHITE | BLANCO
- BLACK | NEGRO
- AUBERGINE | BERENJENA
- TRANSLUCID COLORS  
COLORES TRANSLÚCIDOS:
- FUMÉ
- CYAN
- WINE | VINO

Cubeta interior de plástico PETG | Cubeta exterior de plástico ABS.  
Interior pot of PETG plastic | Exterior pot of ABS plastic.



Ø 20x20

Lina



- TRANSPARENT
- FUCHSIA
- LILAC

Cubeta interior de plástico PETG | Cubeta exterior de plástico ABS.  
Interior pot of PETG plastic | Exterior pot of ABS plastic.

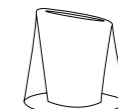

Ø 20x20

## COMPLEMENTOS | ACCESSORIES

Hobby ruedas  
Hobby wheels

4 o 5 unidades  
4 or 5 units



Novo ruedas  
Novo wheels

4 unidades  
4 units



Indicador nivel de agua  
Level indicator

Pequeña, mediana y grande  
Small, medium, large



Indicador nivel de agua - Novo  
Level indicator - Novo

Pequeña, mediana y grande  
Small, medium, large



Bolsa de drenaje  
Drainage bag



Bomba de agua  
Water Pump



## Agradecimientos Special thanks to

Todo el equipo de Hobby Flower y todos los profesionales que hacen posible este proyecto único.  
All the Hobby Flower team and the professionals that are involved in this unique project.

Emiliana Design Studio - [www.emilianadesign.com](http://www.emilianadesign.com)  
Jordi Vilardell  
Kriska Decor - [www.kriskadecor.com](http://www.kriskadecor.com)  
Marçal Vaquer - [www.marssal.net](http://www.marssal.net)  
Carlos Hernandez - [www.carlosbcn.com](http://www.carlosbcn.com)  
Lucid Design Agency - [www.lucid.pro](http://www.lucid.pro)  
Gràfiques Rosenc  
Vertisol "contemporary weavers" - [www.vertisol.com](http://www.vertisol.com)  
Vibia - [www.vibia.com](http://www.vibia.com)  
SB Plaça Europa - [www.hotelsbplazaeuropa.com](http://www.hotelsbplazaeuropa.com)

**HOBBY FLOWER, S.A.**

Edificio Genebre  
Avda. Joan Carles I, 46-48  
08908 l'Hospitalet de Llobregat  
Barcelona (SPAIN)  
Tel. +(34) 93 318 31 16  
Fax +(34) 93 318 31 13

[info@hobbyflower.com](mailto:info@hobbyflower.com)  
[www.hobbyflower.com](http://www.hobbyflower.com)

