

O'FREE /135

Lampada a luce diretta. Costituita da una struttura in MDF e metallo opaco, e un vetro con una lavorazione particolare che assorbe e trasmette la luce LED.

Tecnologia LED.

Lamp with fitting that provides direct light. Made by a structure in MDF and matte metal, and by a glass with a specific detail that absorbs and projects the LED light.

LED technology.



DATI TECNICI/TECHNICAL DATA

TIPOLOGIA - TYPE

SOSPENSIONE
PENDANT

MATERIALI - MATERIALS

VETRO, MDF, METALLO
GLASS, MDF, METAL

SORGENTE LUMINOSA - LIGHT SOURCE

LED 73W 3000K ~5560 lm
110V - 240V

DIMMERAZIONE - DIMMING FUNCTION
1-10VDC, SEGNALE PWM, RESISTENZA
1-10VDC, PWM SIGNAL, RESISTANCE

CLASSE ENERGETICA - ENERGY CLASS

A⁺⁺ - A

CERTIFICAZIONI - MARKS

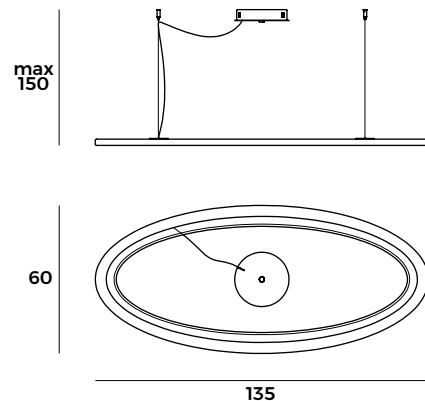

CODICI - CODES

- **F1.087** BIANCO
WHITE
- **F1.088** NERO
BLACK
- **F1.089** FOGLIA ORO
GOLD LEAF

*ACCIUSTARE LA LETTERA PER LA FINITURA SATINATA DEL VETRO
ADD THE LETTER TO THE GLASS SATIN FINISH
xx.xxx/S VETRI SATINATI - SATIN GLASS

ACCESSORI - ACCESSORIES

DISCO CHIUSURA PER INSTALLAZIONE AD INCASSO
COVER DISC FOR RECESSED INSTALLATION

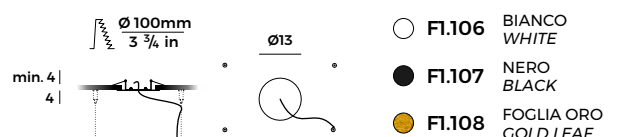

AVVISO - Il flusso luminoso (lm) per tutti gli apparecchi a LED è stimato in base ai valori nominali delle sorgenti LED. I dati tecnici potrebbero essere soggetti a modifiche senza preavviso. Florian srl non fornisce alcuna garanzia legale per l'accuratezza di questa scheda tecnica.

NOTICE - Luminous flux (lm) for all LED luminaires is estimated based on nominal ratings of the LED sources. Technical data could be subject to alteration without notice. Florian srl does not provide legal guarantee for the accuracy of this data sheet.