

LESLIE 10/16

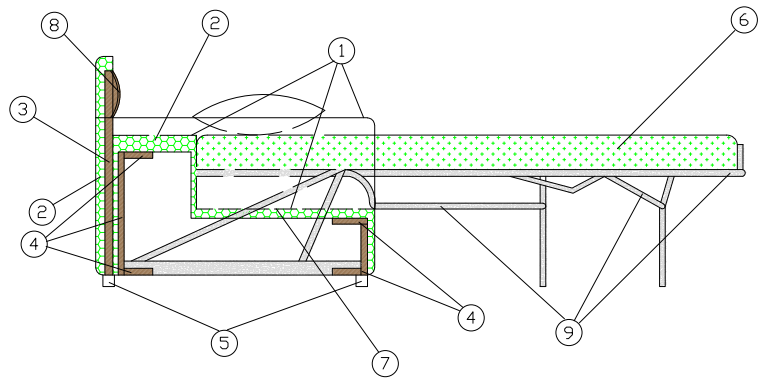
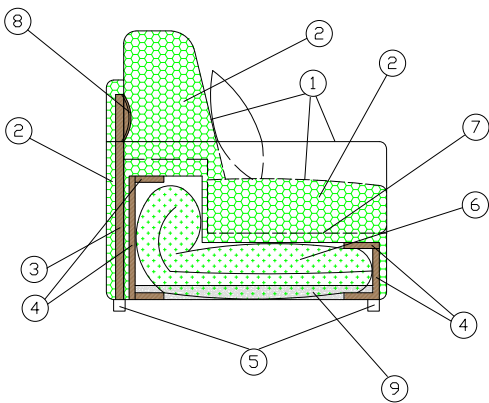

MATERIALI:

- 1- fibra di dacron® 100 gr;
- 2- cuscino seduta in poliuretano espanso flessibile, cuscino schienale in piuma e poliuretano espanso indeformabile;
- 3- tavola in agglomerato di legno;
- 4- telaio in agglomerato di legno;
- 5- piedi in PVC;

- 6- materasso in poliuretano espanso a due pieghe normale o ignifugo, h 12 cm, rivestito con tessuto anallergico composto da poliestere;
- 7- cinghie elastiche intrecciate;
- 8- cuffia in legno di masonite;
- 9- rete elettrosaldada di acciaio ad alta resistenza.

LESLIE 10/16

BRACCIOLO:



LESLIE 10/16 COLLECTION:

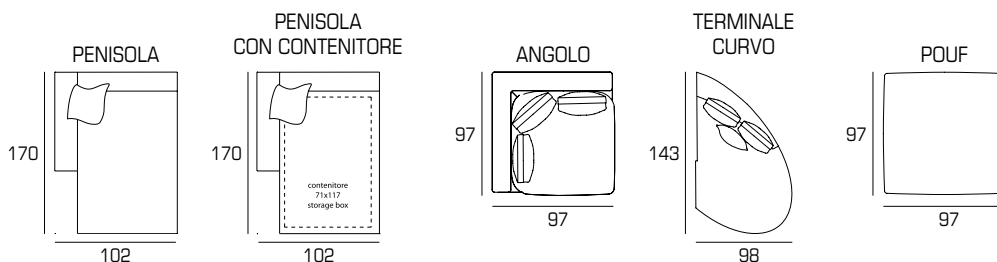
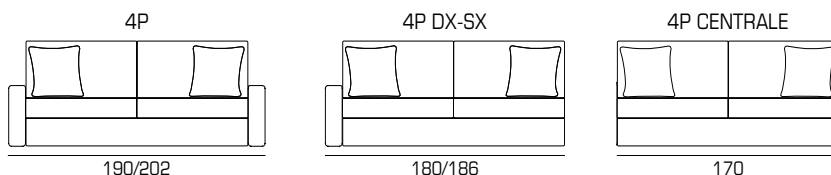
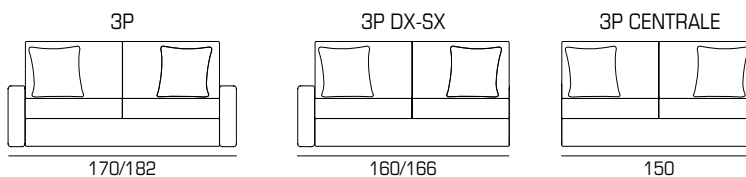
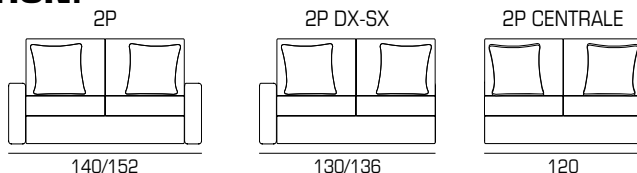
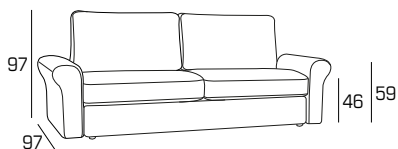

PIEDI:

P 25 h 2-4-6

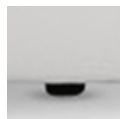

LETTO:

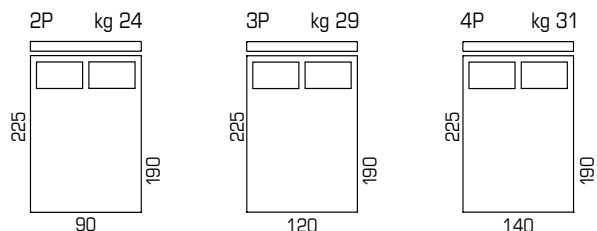

LESLIE 10/16

MECCANISMO LETTO:

Apertura

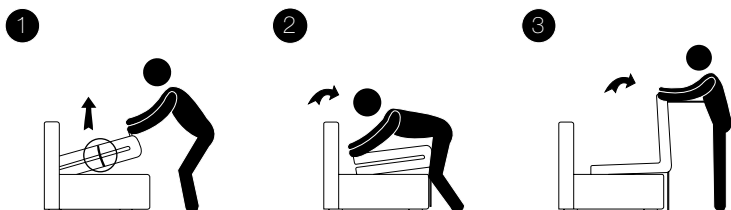

RIMUOVERE
le fascette ai lati prima
di sollevare la rete

Un'errata apertura del letto
può provocare
la rottura del meccanismo

Chiusura

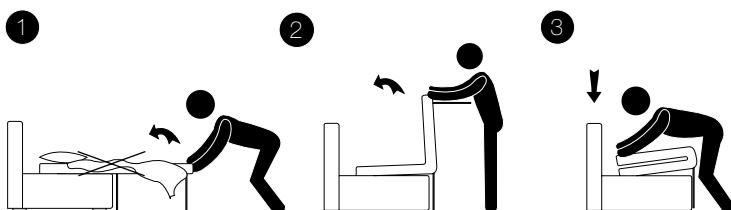

RIMUOVERE
lenzuola, coperte o cuscini prima
della chiusura del letto per evitare
danni al meccanismo

INFORMAZIONI TECNICHE:

Sfoderabile: NO	kg	m ³	mts	kg	m ³	mts	
LESLIE 10 2P	63	1.30	9.60	LESLIE 10 4P LATERALE	84	1.70	9.50
LESLIE 10 2P LATERALE	54	1.20	8.10	LESLIE 10 4P CENTRALE	75	1.60	8.50
LESLIE 10 2P CENTRALE	45	1.10	7.00	LESLIE 10 PENISOLA	79	1.50	8.30
LESLIE 10 3P	84	1.60	10.50	LESLIE 10 PENISOLA CON CONTENITORE 79	79	1.50	8.30
LESLIE 10 3P LATERALE	75	1.50	9.00	LESLIE 10 ANGOLO	45	0.90	8.00
LESLIE 10 3P CENTRALE	66	1.40	8.00	LESLIE 10 TERMINALE CURVO	46	1.35	8.10
LESLIE 10 4P	93	1.80	11.00	LESLIE 10 POUF	26	0.90	3.80
LESLIE 16 2P	64	1.40	9.80	LESLIE 10 4P LATERALE	85	1.75	9.60
LESLIE 16 2P LATERALE	55	1.25	8.20	LESLIE 10 4P CENTRALE	75	1.60	8.50
LESLIE 16 2P CENTRALE	45	1.10	7.00	LESLIE 10 PENISOLA	80	1.60	8.40
LESLIE 16 3P	85	1.70	10.70	LESLIE 10 PENISOLA CON CONTENITORE 80	80	1.60	8.40
LESLIE 16 3P LATERALE	76	1.55	9.10	LESLIE 10 ANGOLO	45	0.90	8.00
LESLIE 16 3P CENTRALE	66	1.40	8.00	LESLIE 10 TERMINALE CURVO	46	1.35	8.10
LESLIE 16 4P	94	1.90	11.20	LESLIE 10 POUF	26	0.90	3.80