

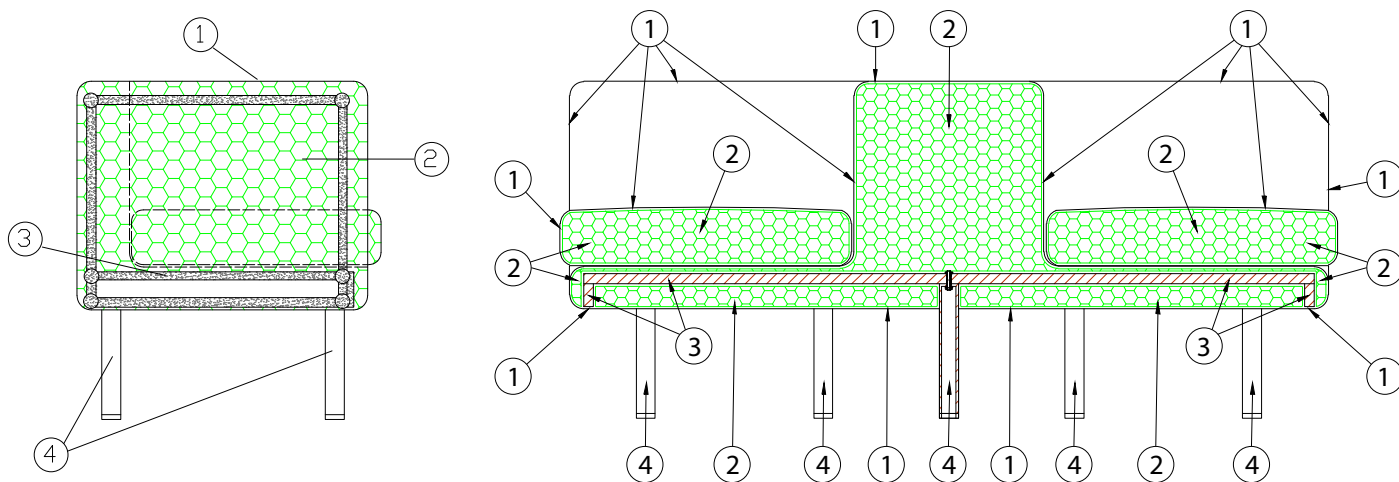

Da una forma geometrica basico nasce Otto una collezione innovativa, dinamica e funzionale. La forza di Otto è la semplicità delle forme e la capacità di inserirsi nell'ambiente assolvendo una funzione molto precisa di seduta da attesa fuori dagli schemi.



### 1P-2P - MATERIALI:

- 1 - fibra di dacron® 100 gr;
- 2 - poliuretano espanso indeformabile di diverse densità;
- 3 - telaio in tubolare metallico;
- 4 - gambe in metallo cromato.

### CENTRO-STANZA - MATERIALI:

- 1 - fibra di dacron® 100 gr;
- 2 - poliuretano espanso indeformabile di diverse densità;
- 3 - telaio in multistrato di legno di abete;
- 4 - gambe in metallo cromato.

### DIMENSIONI:

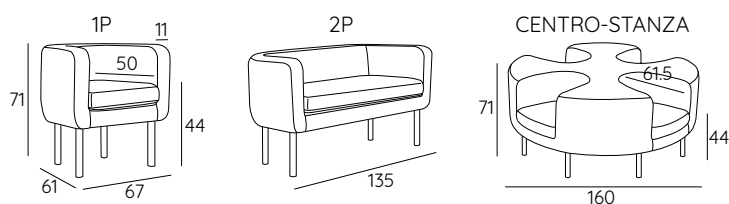

**GAMBE:**

h 23



**INFORMAZIONI TECNICHE:**

Sfoderabile: NO	kg	m <sup>3</sup>	mts
OTTO 1P	13	0.29	(1)2.10 (2)1.30 (3)1.30
OTTO 2P	23	0.58	(1)4.50 (2)2.50 (3)2.50
OTTO CENTRO-STANZA	59	1.82	(1)8.50 (2)5.50 (3)5.00

**1P**

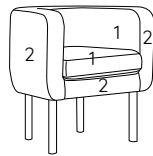

**2P**

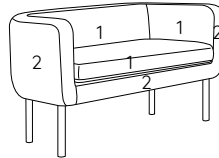

**Centro-stanza**

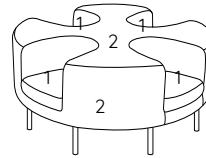

**RIVESTIMENTI CONSIGLIATI:**



Lemming 29500



Luna/Z CS



Amara



Mirage



Sprint



Sole CS



Nemi melange



Angel combo



Angel chevy



Angel jumbo

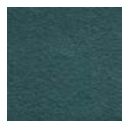

Europost 2



Natur wool

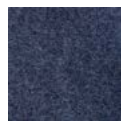

Fenice



Vintage



Tiffany contract



Polaris Pro



Happy



Parasol 100