

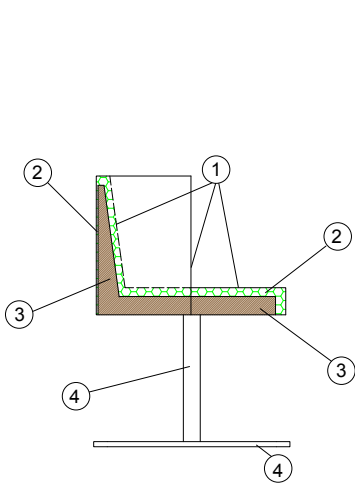

Tigram: l'arte di giocare con le forme geometriche e trasformarle in divani e poltrone.

Partendo dal concetto del Tangram, antico gioco cinese basato sulla componibilità di 7 forme geometriche con le quali si possono costruire infiniti disegni e figure, Tigram si sviluppa sulla base di forme geometriche semplici, su elementi primari componibili che le permettono di trasformarsi in un insieme complesso di figure liberamente interpretabili sia per chi le progetta, sia per chi le osserva. 7 elementi tra poltrone, divani, pouf e sgabelli, tutti rigorosamente modellati su una base esagonale, con diverse dimensioni ed altezze, disponibili in un'ampia varietà di colori, si uniscono e si separano creando figure e simboli e cromie mutanti come in un caleidoscopio. È una collezione perfetta per arredare locali pubblici che hanno la necessità di arredi flessibili e modulari, facilmente adattabili ai diversi momenti di vita dei luoghi vissuti da collettività in movimento, che mutano continuamente l'ambiente in cui si spostano. Tigram non è solo un insieme articolato, ma anche un singolo pezzo scelto ad hoc per un corner sofisticato o un angolo chiacchiere esclusivo di un ambiente domestico frutto di ricerca e studio, nel quale Tigram si inserisce nella versione con schienale basso, nel ruolo di divanetto discreto o di trono altezzoso.



CHAIR - MATERIALI:

- 1 - fibra di dacron® 100 gr;
- 2 - poliuretano espanso indeformabile di diverse densità;
- 3 - telaio in multistrato di legno;
- 4 - base girevole in inox lucido e colonna in metallo cromato.

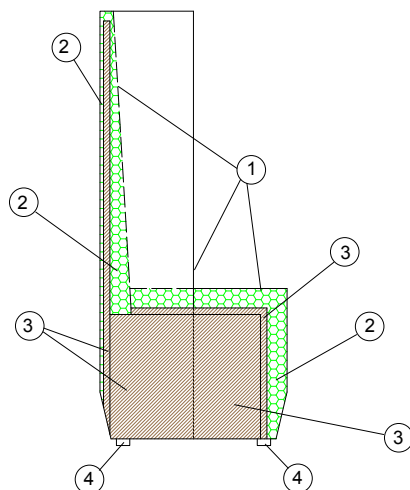

LOW-HIGH - MATERIALI:

- 1 - fibra di dacron® 100 gr;
- 2 - poliuretano espanso indeformabile di diverse densità;
- 3 - telaio in multistrato di legno;
- 4 - piedi in PVC.

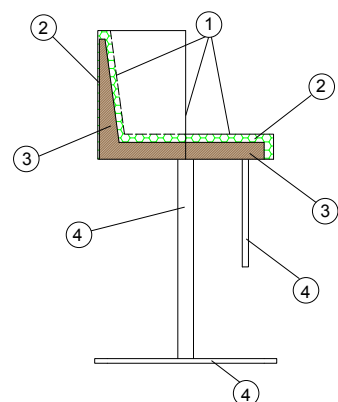

STOOL - MATERIALI:

- 1 - fibra di dacron® 100 gr;
- 2 - poliuretano espanso indeformabile di diverse densità;
- 3 - telaio in multistrato di legno;
- 4 - base girevole in inox lucido e colonna in metallo cromato.



DESIGN ITALO PERTICHINI

TIGRAM

DIMENSIONI:

Low

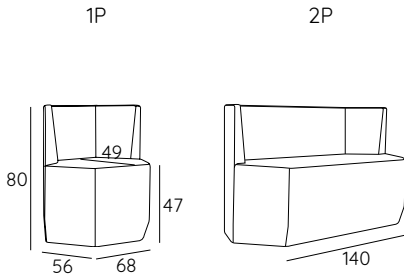

High

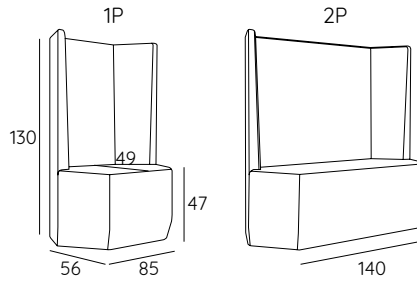

Chair

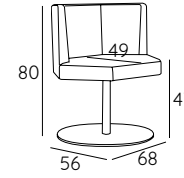

Stool

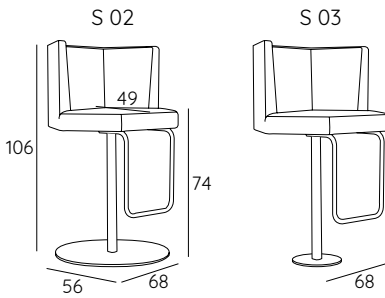

Pouf

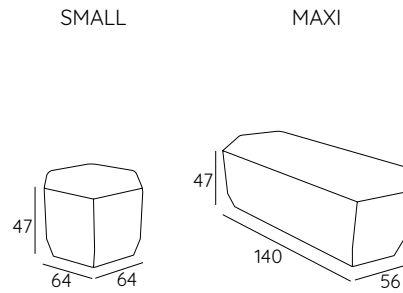

PIEDIE BASI:

Low e High



Chair



Stool



Pouf



FINTURE METALLO BASI:



INFORMAZIONI TECNICHE:

Sfoderabile: NO	kg	m ³	mts		kg	m ³	mts
TIGRAM LOW 1P	20	0.30	2.80	TIGRAM STOOL S 02	32	0.40	2.80
TIGRAM LOW 2P	39	0.63	4.00	TIGRAM STOOL S 03	25	0.40	2.80
TIGRAM HIGH 1P	34	0.62	3.80	TIGRAM POUF SMALL	13	0.19	1.20
TIGRAM HIGH 2P	48	1.02	5.00	TIGRAM POUF MAXI	30	0.37	2.80
TIGRAM CHAIR	24	0.30	2.80				

COMPOSIZIONI SUGGERITE:

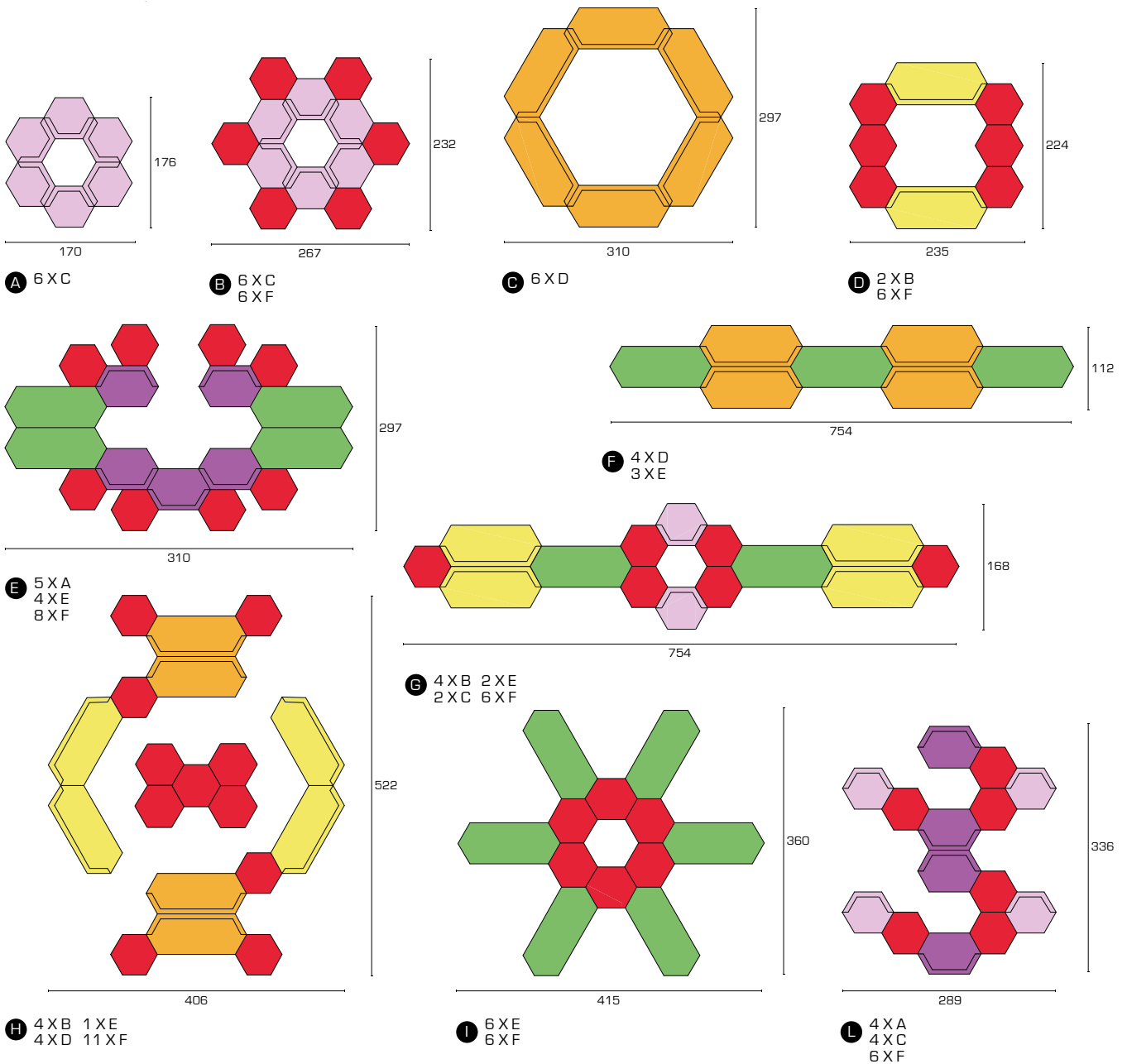
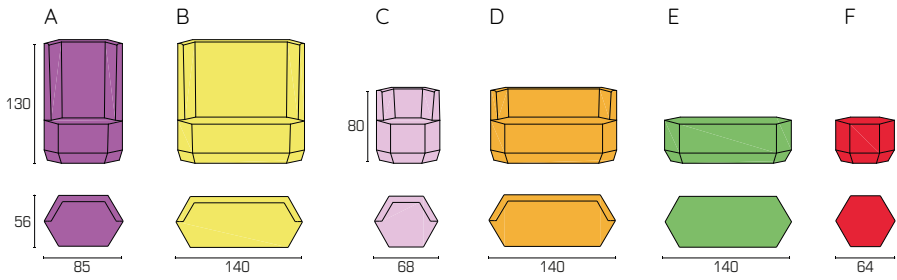

11M

DESIGN ITALO PERTICHINI

TIGRAM

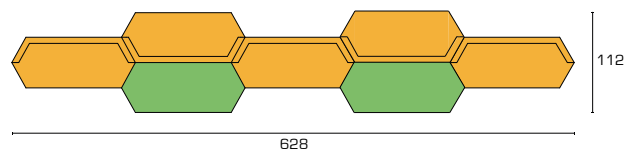

M 5 XD
2 XE

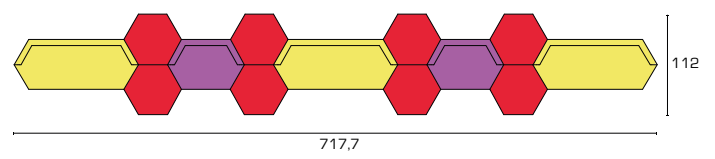

N 2 XA
3 XB
8 XF

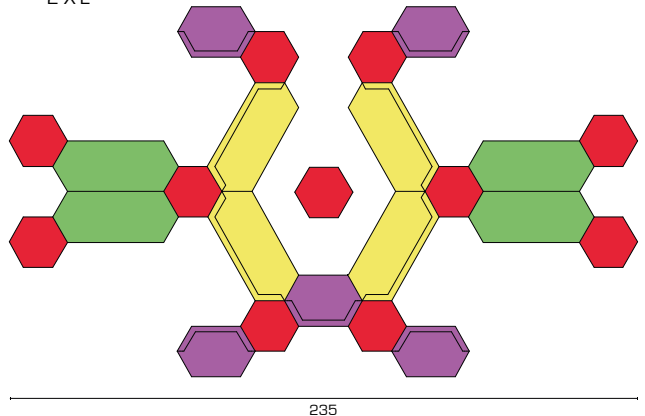

O 5 XA 4 XE
4 XB 11 XF

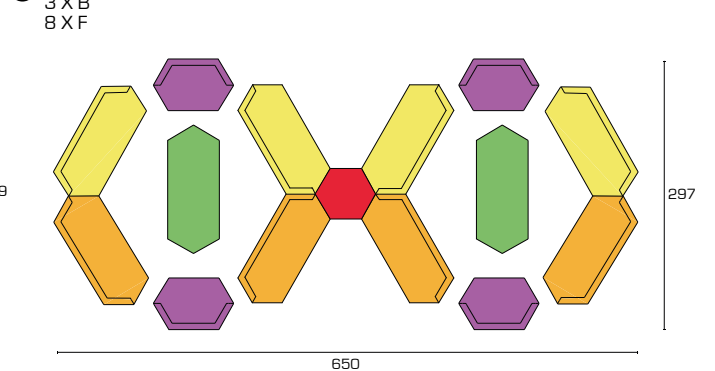

P 4 XA 2 XE
4 XB 1 XF
4 XD

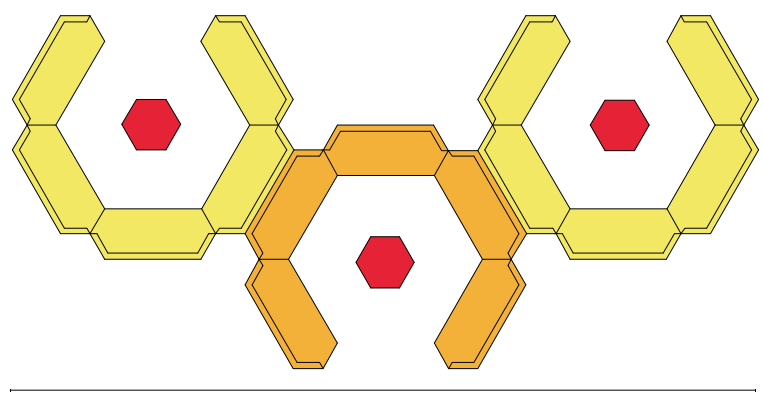

Q 10 XB
5 XD
3 XF

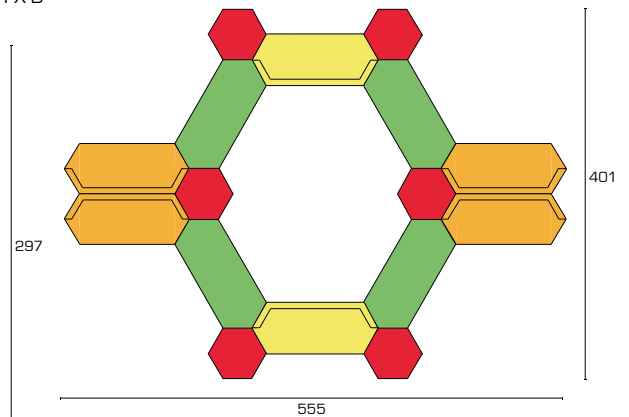

R 12 XB
6 XD
3 XF

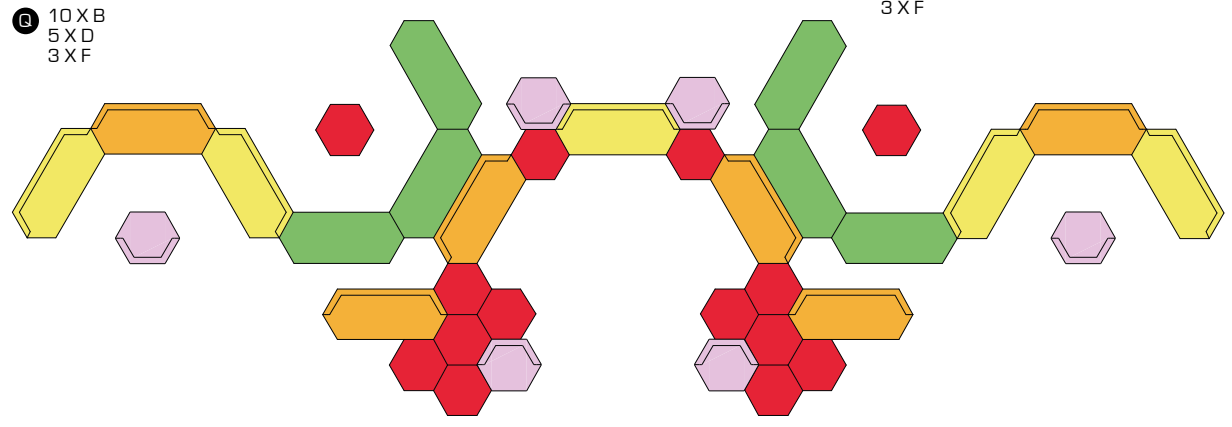

S 5 XB 6 XE
6 XC 14 XF
6 XD



DESIGN **ITALO PERTICHINI**

TIGRAM

RIVESTIMENTI CONSIGLIATI:



Lemming 29500



Luna/Z CS



Amara

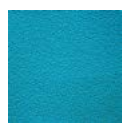

Mirage



Sprint



Sole CS



Nemi melange



Angel combo

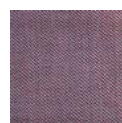

Angel chevvy

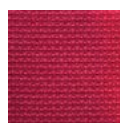

Angel jumbo



Europost 2

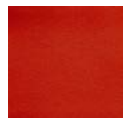

Natur wool

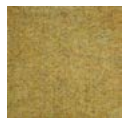

Fenice



Vintage



Tiffany contract

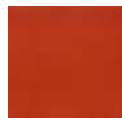

Polaris Pro



Happy

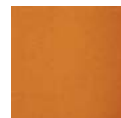

Parasol 100