

[En] → **BI-emission lighting.**

The constructive principle of the lamp allows a double light emission. This detail makes the product capable of illuminating the surrounding space with a 360 degrees light. The upper and lower light emission are equal both for what concerns quantity and colour giving a completely homogeneous effect.

**BI-emissione luminosa**

[It] → Il principio costruttivo delle lampade rende possibile una doppia emissione luminosa: in tal modo l'ambiente circostante viene illuminato a 360 gradi. Inoltre, la luce orientata verso l'alto e verso il basso è uguale sia per quantità che per colore al fine di rendere il flusso di luce completamente omogeneo.

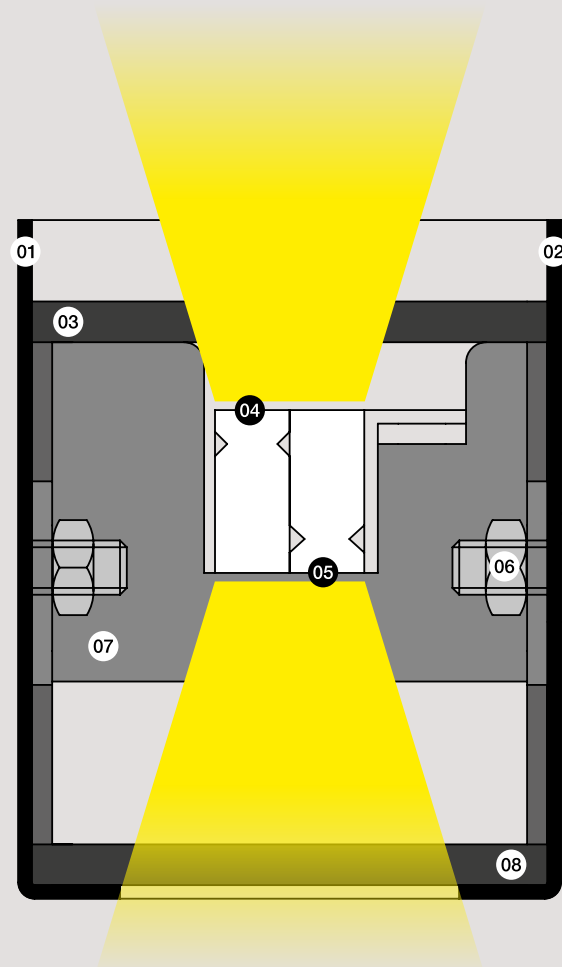

- 01 Metal profile 01.**  
Profilo 01 in metallo.
- 02 Metal profile 02.**  
Profilo 02 in metallo.
- 03 Upper white PMMA diffuser.**  
Diffusore superiore in PMMA bianco.
- 04 Light source - Strip LED.**  
**Light emission UP.**  
Sorgente luminosa - Strip LED.  
Emissione luminosa verso l'alto.
- 05 Light source - Strip LED.**  
**Light emission DOWN.**  
Sorgente luminosa - Strip LED.  
Emissione luminosa verso il basso.
- 06 Mechanical fixing of the metal bracket.**  
Fissaggio meccanico della staffa in metallo.
- 07 Metal bracket: Strip LED support / union of profile 01 & 02.**  
Staffa in metallo: supporto strip LED / unione profilo 01 & profilo 02.
- 08 Lower white PMMA diffuser.**  
Diffusore inferiore in PMMA bianco.

**RING** collection

design L4B

SO 80

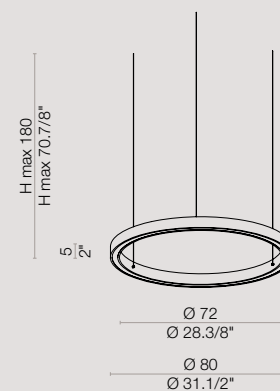

SO 120

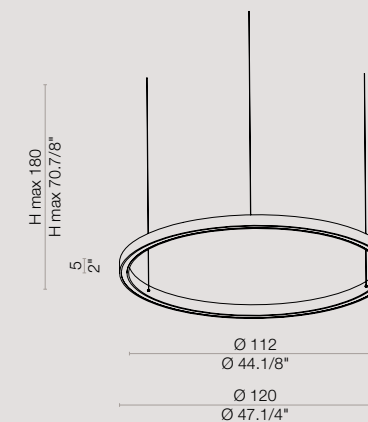

**material**

metal and PMMA  
metallo e PMMA

**light source**

LED 220-240V

120V for  
NORTH AMERICA

**equipment**

**SO 80**  
75W 3000°K Im 2000 UP Im 2000 DOWN

**SO 120**  
115W 3000°K Im 3250 UP Im 3250 DOWN

**symbols**



**colors**

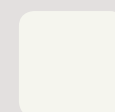

white / bianco  
RAL 9010

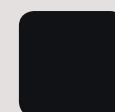

black / nero  
RAL 9005

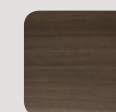

brushed bronze  
/ bronzo spazzolato

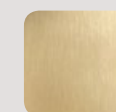

brushed gold  
/ oro spazzolato

**energy label**

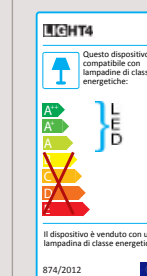

label A