

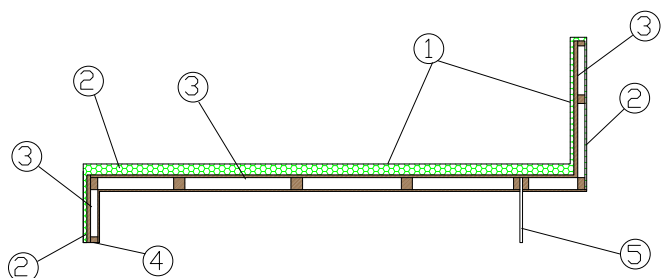

Micromega mette al centro l'uomo con le sue necessità di incontro e socializzazione in spazi definiti, accoglienti ed estetici; da qui il senso di mutuare simbolicamente le figure del cerchio e del quadrato dallo schema vitruviano di Leonardo. Micromega è una micro-architettura destinata a mega spazi pubblici, e consente di realizzare aggregazioni infinite e di forte impatto. Micromega è un sistema imbottito modulare di sedute per il contract ed il settore office, ma con moduli di piccole dimensioni utilizzabili anche in spazi domestici contemporanei.



SEDUTE - MATERIALI:

- 1 - fibra di dacron® 100 gr;
- 2 - poliuretano espanso indeformabile di diverse densità;
- 3 - telaio in multistrato di legno;
- 4 - piedi in PVC;
- 5 - piede in multistrato di legno rivestito in inox lucido/piede in plexiglass.

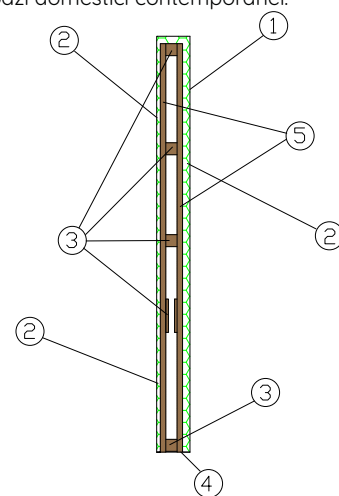

SCHIENALI - MATERIALI:

- 1 - fibra di dacron® 100 gr;
- 2 - poliuretano espanso indeformabile di diverse densità;
- 3 - telaio in multistrato di legno;
- 4 - piedi in PVC;
- 5 - telaio in MDF.



DESIGN **ROBERTO ROMANELLO**

MICROMEGA

DIMENSIONI:

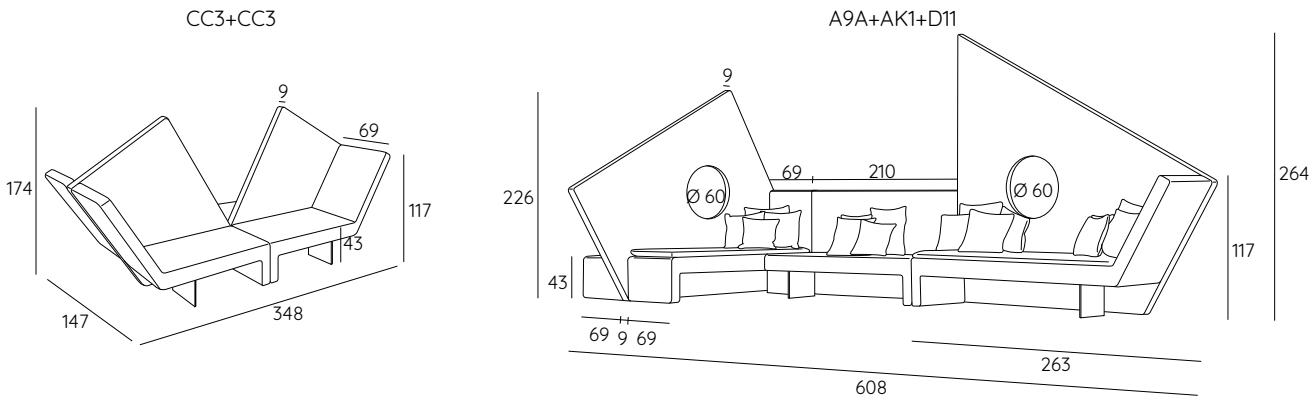

CUSCINO SEDUTA MOVIBILE



CUSCINI

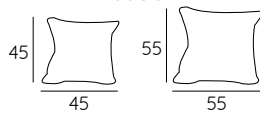

PIEDI:

plexiglass h 28 acciaio h 28 h 2



INFORMAZIONI TECNICHE:

Sfoderabile: SI SU RICHIESTA	kg	m ³	mts		kg	m ³	mts
MICROMEGA SEDUTA A	/	1.54	4.20	MICROMEGA SCHIENALE 7	/	0.51	11.65
MICROMEGA SEDUTA AK	/	0.59	3.20	MICROMEGA SCHIENALE 8	/	0.49	11.00
MICROMEGA SEDUTA B	/	2.15	5.20	MICROMEGA SCHIENALE 9	/	0.53	12.00
MICROMEGA SEDUTA BK	/	0.81	4.70	MICROMEGA SCHIENALE 10	/	0.63	13.20
MICROMEGA SEDUTA C	/	1.40	4.20	MICROMEGA SCHIENALE 11	/	0.62	12.65
MICROMEGA SEDUTA D	/	2.12	5.20				
				CUSCINO SEDUTA MOVIBILE	0.50	/	1.60x1 mtl
MICROMEGA SCHIENALE 1	/	0.20	4.70	CUSCINO 45X45	0.50	0.02	0.50
MICROMEGA SCHIENALE 2	/	0.28	6.20	CUSCINO 55X55	0.50	0.03	0.60
MICROMEGA SCHIENALE 3	/	0.26	7.70				
MICROMEGA SCHIENALE 4	/	0.29	7.80	COMPOSIZIONE CC3+CC3	/	8.90	(1) 16.80 (2) 15.40
MICROMEGA SCHIENALE 5	/	0.38	9.60	COMPOSIZIONE A9A+AK1+D11	/	42.20	(1) 17.80 (2) 29.35
MICROMEGA SCHIENALE 6	/	0.33	7.65				

CC3+CC3

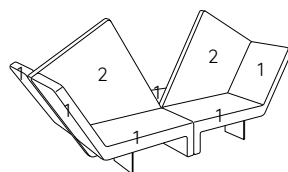

A9A+AK1+D11

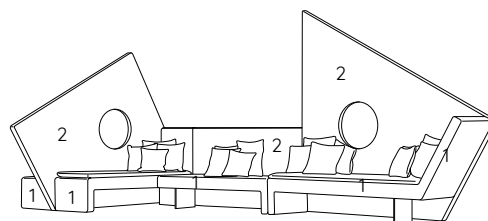

SOLUZIONI PER UFFICIO:

1

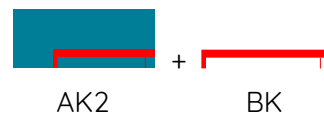
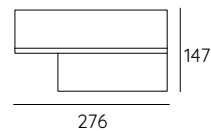
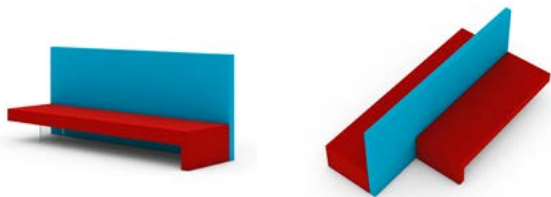

2

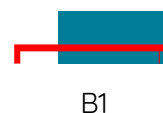
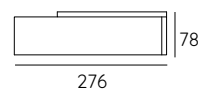
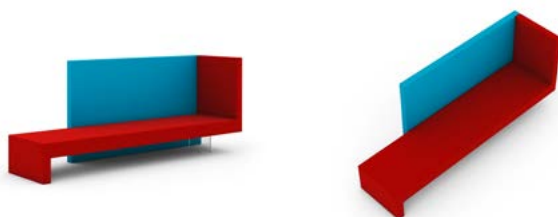

3

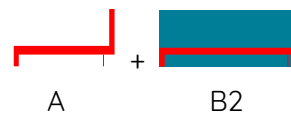
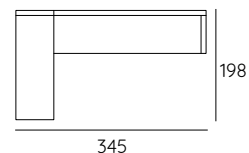
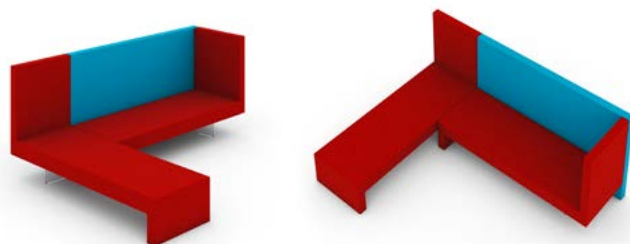

4

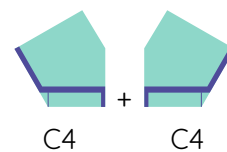
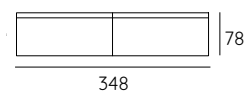
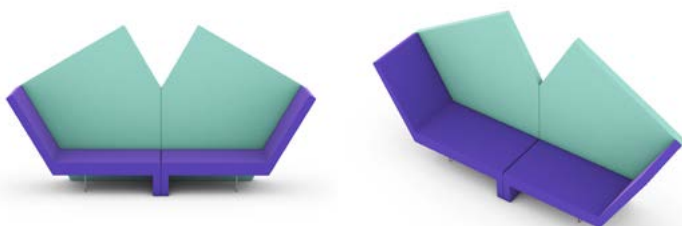

5

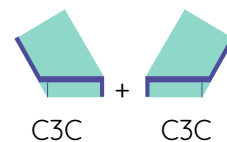
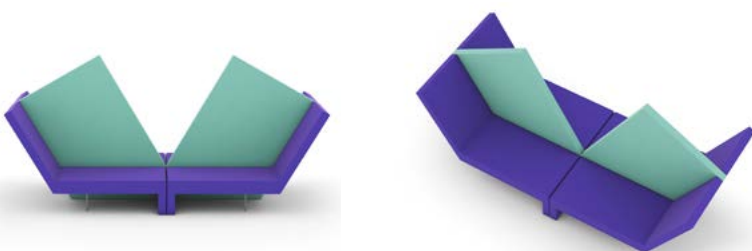

6

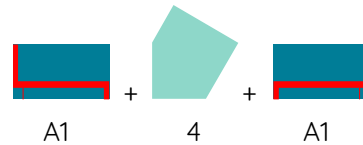
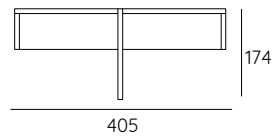
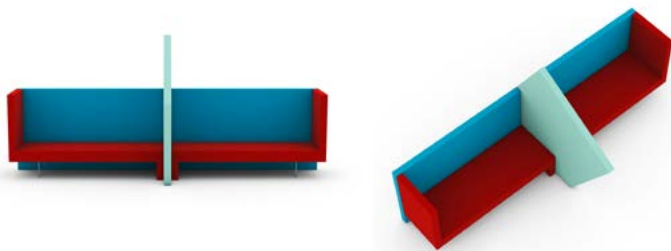

7

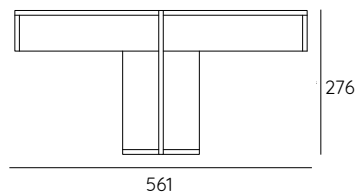
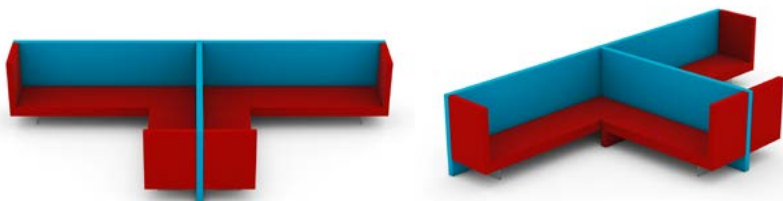

8

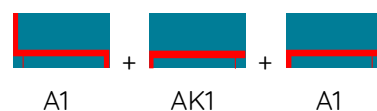
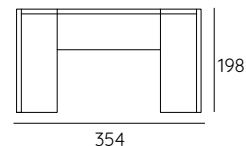
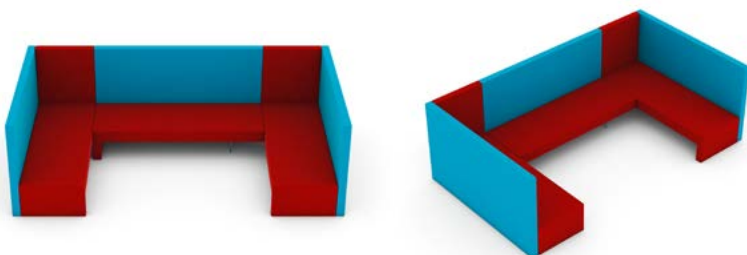

9

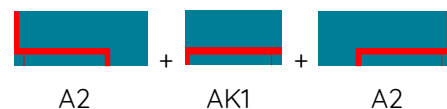
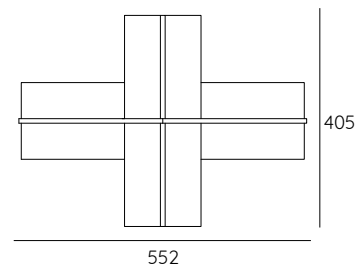
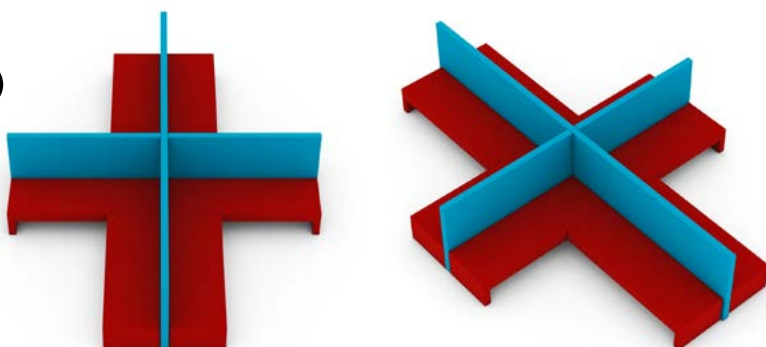

11M

DESIGN **ROBERTO ROMANELLO**

MICROMEGA

SOLUZIONI PER IL CONTRACT:

1

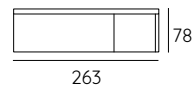
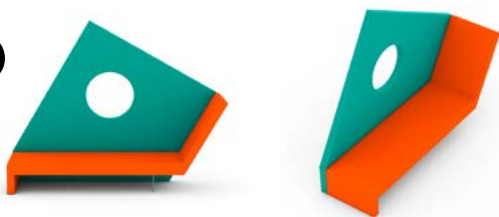

D8

2

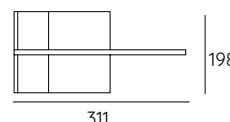
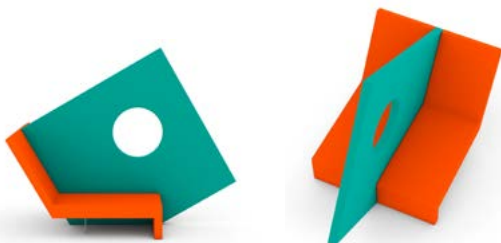

D10D

3

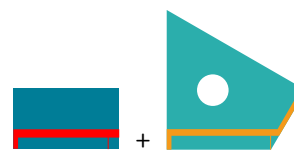
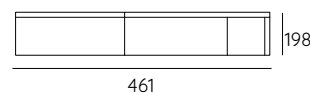
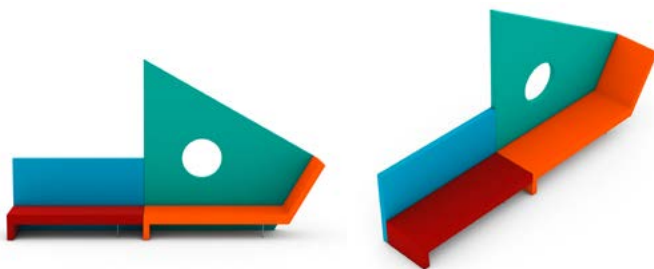

AK1

D11

4

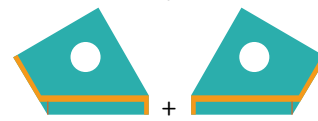
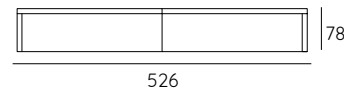

D8

D8

5

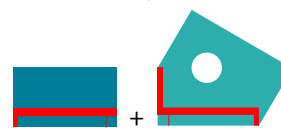
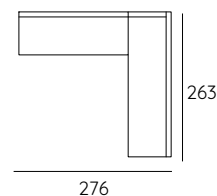
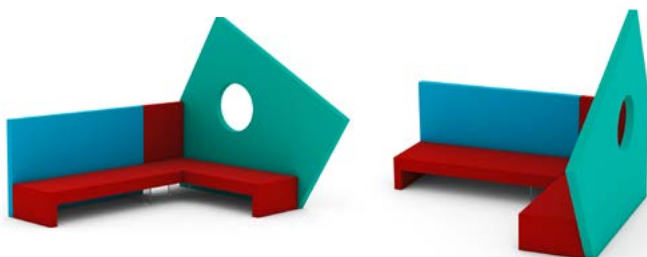

AK1

A9

adrenajina
WE ARE DIFFERENT!

MICROMEGA

6

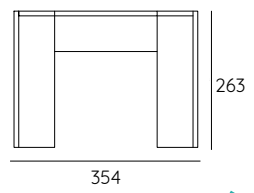
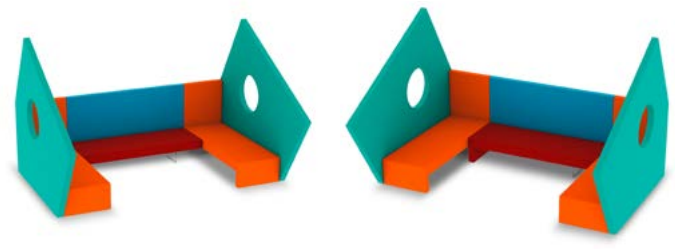

7

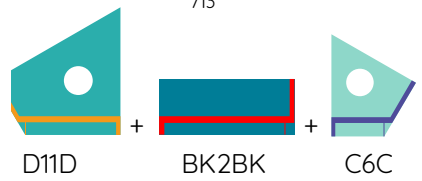
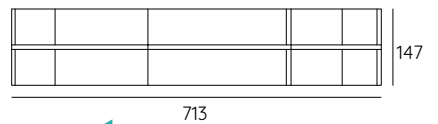
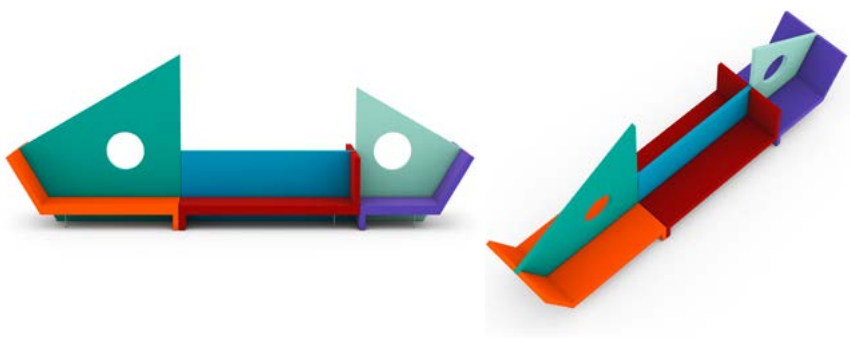

8

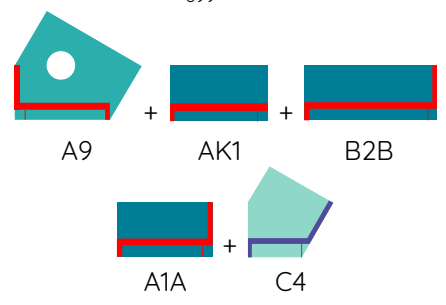
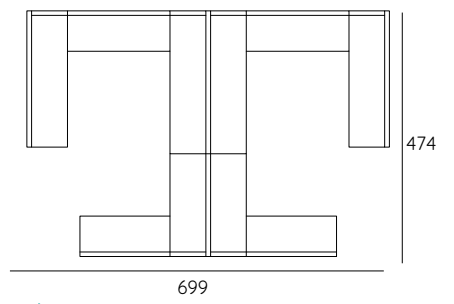
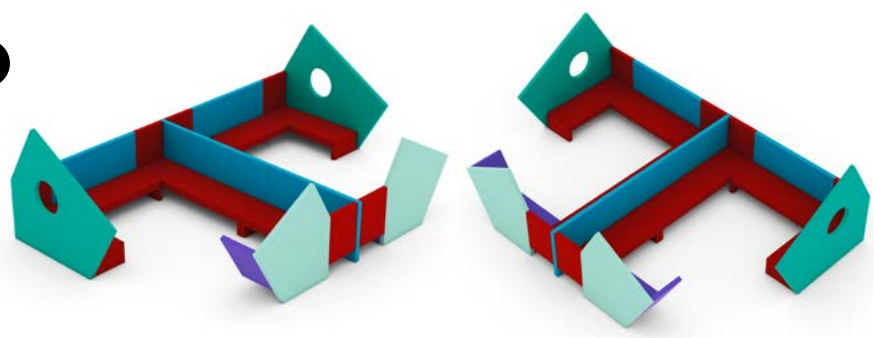

COMPOSIZIONI SUGGERITE:

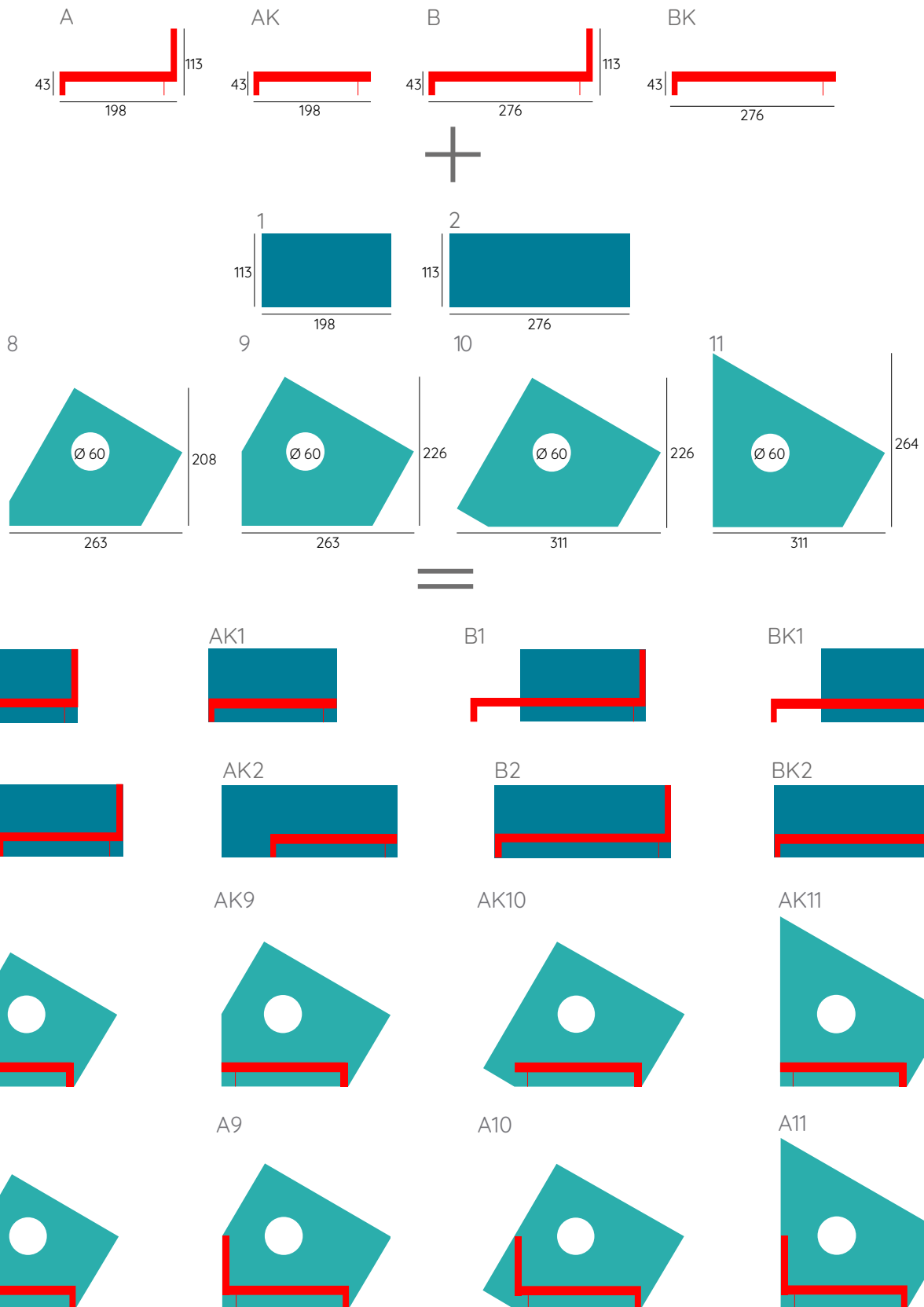

MICROMEGA

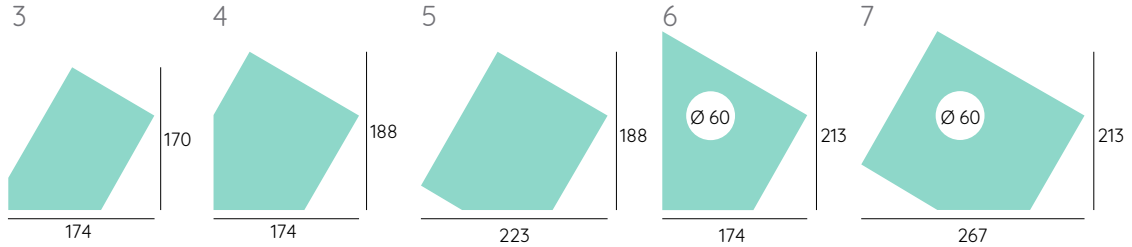
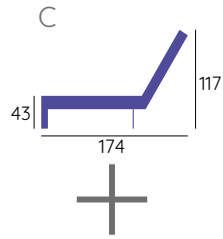

=

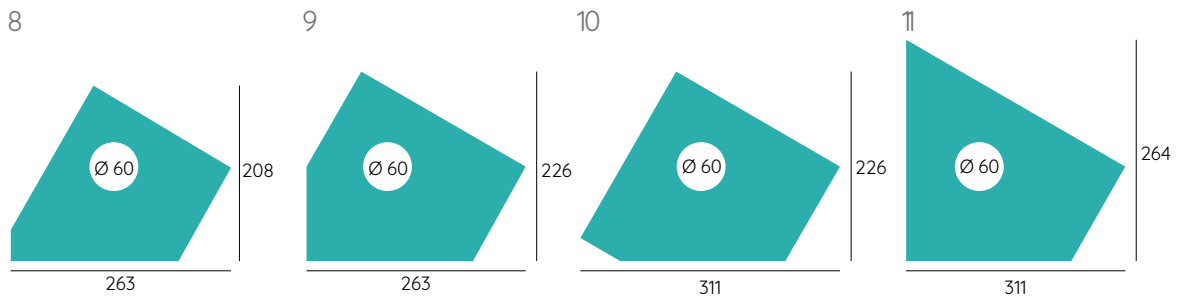
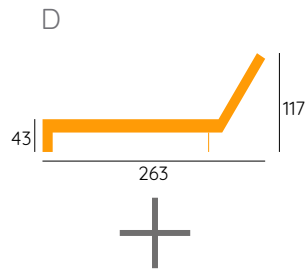
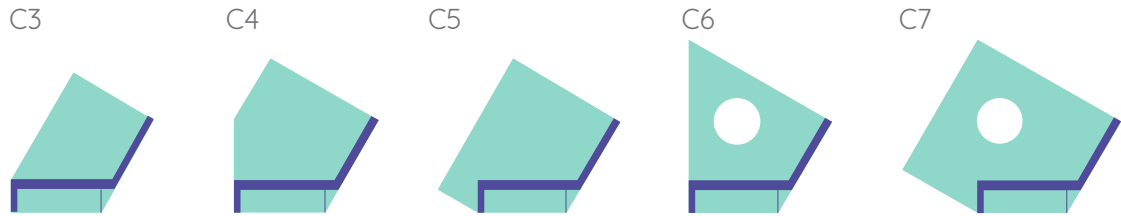

=





DESIGN **ROBERTO ROMANELLO**

MICROMEGA

RIVESTIMENTI CONSIGLIATI:



Lemming 29500



Luna/Z CS



Amara

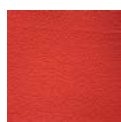

Mirage



Sprint



Sole CS

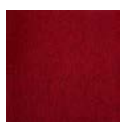

Nemi melange

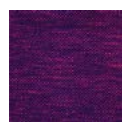

Angel combo



Angel chevy



Angel jumbo



Europost 2



Natur wool

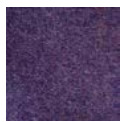

Fenice



Vintage



Tiffany contract



Polaris Pro



Happy



Parasol 100