

KATE



Sedia. Struttura in multistrato curvato di pioppo italiano. Imbottitura in poliuretano espanso a quote differenziate. Base in massiccio di Frassino tinto Moka. Schienale in metallo, finitura Bronzo Antico. Schienale e seduta in tessuto o pelle. Rivestimento non sfoderabile .

Chair. Structure in bented multilayer Italian poplar wood. Variable-density polyhuretane foam padding. Base in solid Moka stained Ashwood, rear back in metal, Antique Bronze finish. Inner back and seat upholstered in fabric or leather. Not removable covers



100% made in Italy



www.bellavistacollection.com

KATE

Finiture standard Base | *Standard finishes - Base*



FRM | Frassino tinto Moka
Moka stained Ashwood

Finiture standard Schienale | *Standard finishes - Back*



BA | Bronzo Antico
Antique Bronze

Misure standard | *Standard sizes*

C-09-A

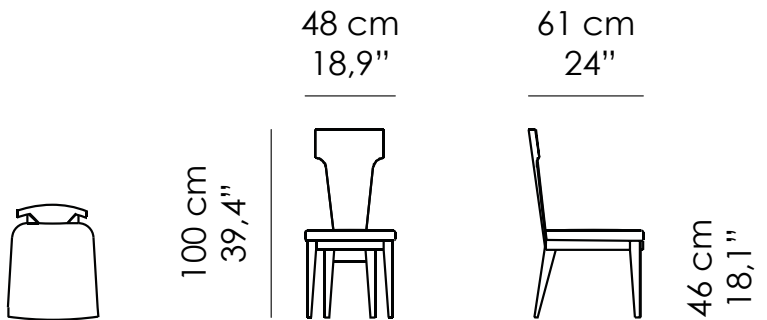

C-09-B

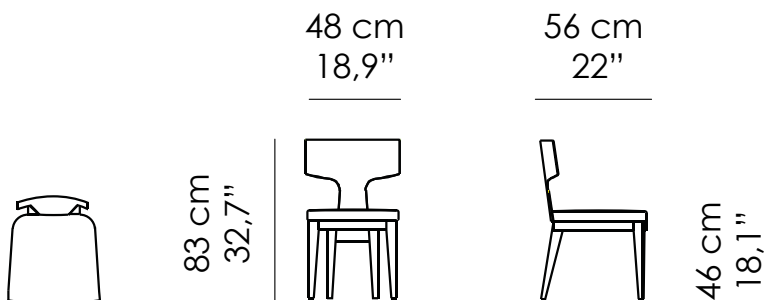

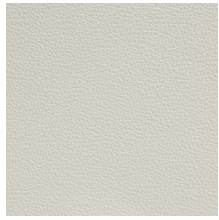

P1.02



P1.03



P1.04



P1.05



P1.07



P1.10



P1.12



P1.13



P1.15



P1.16

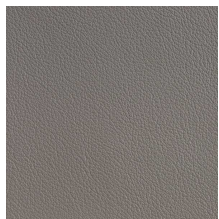

P1.17



P1.19



P1.20



P1.21



P1.24



P1.29



P1.30



P1.32



P1.34



P1.38



P1.39



P1.41



P1.44

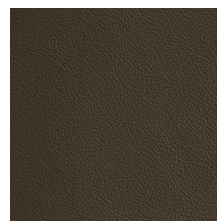

P1.45

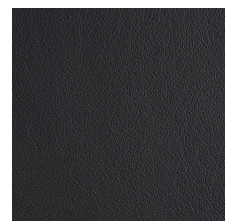

P1.46

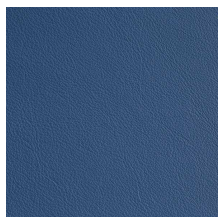

P1.49



P1.50



P1.51

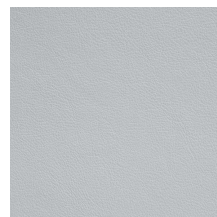

P1.55



P1.56

COLORI E FINITURE PURAMENTE INDICATIVI | *COLORS AND FINISHES ARE INDICATIVE ONLY.*

PELLE cat. P3 - LEATHER cat. P3

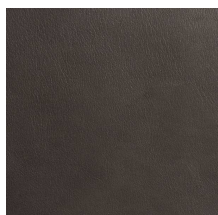

P3 A.01

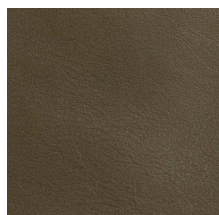

P3 A.02

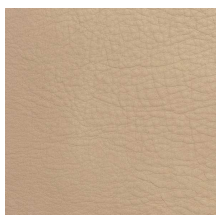

P3 A.03



P3 A.04



P3 B.01



P3 C.01

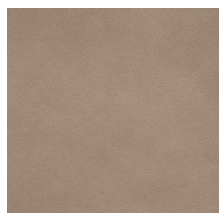

P3 C.02

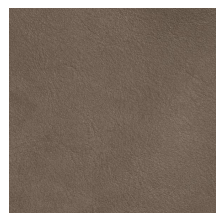

P3 C.03



P3 C.04

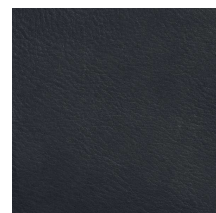

P3 C.05

PELLE cat. P3. Nabuck - LEATHER cat. P3. Nabuck



P3 N.01



P3 N.02

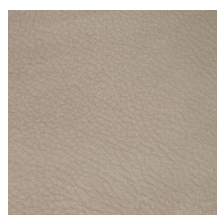

P3 N.03



P3 N.04



P3 N.05



P3 N.06



P3 N.07



P3 N.08



P3 N.09

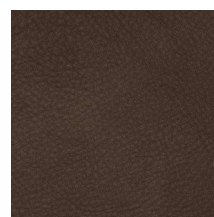

P3 N.10



P3 N.11

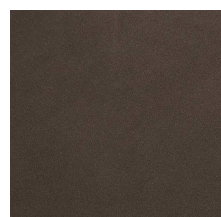

P3 N.12



P3 N.13

COLORI E FINITURE PURAMENTE INDICATIVI | *COLORS AND FINISHES ARE INDICATIVE ONLY.*
