

Palace rectangular

design Lievore Altherr Molina

SOVET



ITALIA

Tavolo con base in inox satinato,
 metallo laccato varie finiture o brunito.
 Top in vetro temperato laccato, legno o
 ceramica, varie finiture.

Dining table with base in mat stainless
 steel, in lacquered metal various finishes or
 burnished finish. Lacquered tempered glass,
 wood or ceramic top, various finishes.

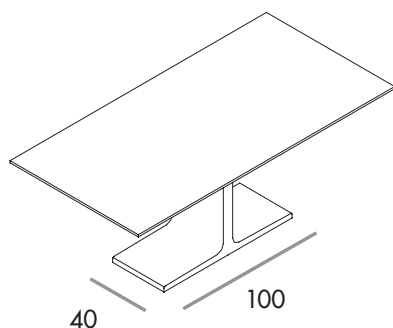
FORME E DIMENSIONI / SHAPES AND DIMENSIONS



-  200x100x74h
-  250x100x74h
-  240x120x74h

FINITURE STRUTTURA / STRUCTURE FINISHES

Acciaio Inox/Stainless steel



IX

Metallo laccato/Lacquered metal



































GB GN GT GC BR

★ Top in ceramica laminato: 6 mm ceramica + 8 mm vetro

Laminated ceramic top: 6 mm ceramic + 8 mm glass

FINITURE TOP / TOP FINISHES

VETRO EXTR. EXTR. GLASS	ACIDATO FROSTED	CERAMICA CERAMIC		LEGNO WOOD
Lacquered Cat. B/D	Lacquered Cat. E	CE1	CE2	RN/RG/WG/NC
		★	★	
 TEB1	 AEB1	 CT	 CA	 RN
 TEC1	 AEC1	 CD	 CO	 RG
 TEC2	 AEC2	 CG	 CI	 WG
 TEC3	 AEC3	 CM	 CU	 NC
 TER4	 AER4	 CX	 CY	
 TEV2	 AEV2	 CC	 CL	
 TEN1	 AEN1	 CZ	 CQ	
 TEM6	 AEM6			
 TES1	 AES1			

Palace barrel shaped-elliptical

design Lievore Altherr Molina

SOVET
ITALIA

Tavolo con base in inox satinato o metallo laccato, varie finiture.
Top in vetro temperato laccato, legno o ceramica, varie finiture.

Dining table with base in mat stainless steel or in lacquered metal, various finishes.
Lacquered tempered glass, wood or ceramic top, various finishes.

FORME E DIMENSIONI / SHAPES AND DIMENSIONS

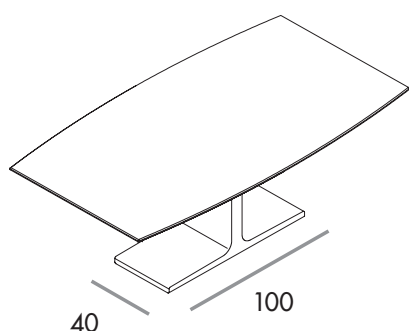

200x110x74h

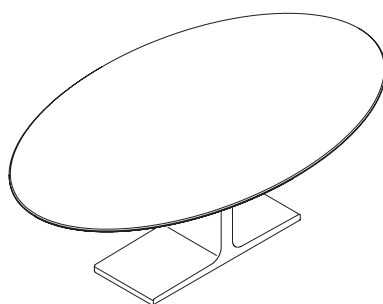

200x110x74h

220x130x74h

FINITURE STRUTTURA / STRUCTURE FINISHES

Acciaio Inox/Stainless steel



IX

Metallo laccato/Lacquered metal



GB GN GT GC BR

FINITURE TOP / TOP FINISHES

VETRO EXTR.
EXTR. GLASS

Lacquered
Cat. B/D

TEB1
TEC1
TEC2
TEC3
TEC3
TER4
TEV2
TEN1
TEM6
TES1

ACIDATO
FROSTED

Lacquered
Cat. E

AEB1
AEC1
AEC2
AEC3
AEC3
AER4
AEV2
AEN1
AEM6
AES1

CERAMICA
CERAMIC

CE1

CE2

*
CT
CD
CG
CM
CX
CC
CZ

*
CA
CO
CI
CU
CY
CL
CQ

* Top in ceramica laminato: 6 mm ceramica + 8 mm vetro

Laminated ceramic top: 6 mm ceramic + 8 mm glass

Palace extensible

design Lievore Altherr Molina

SOVET
ITALIA

Tavolo con base in inox satinato, metallo laccato varie finiture o brunito. Top in vetro temperato laccato o ceramica, varie finiture. Struttura allungabile con finitura alluminio.

Extensible dining table with base in mat stainless steel, in lacquered metal various finishes or burnished finish. Lacquered tempered glass or ceramic top, various finishes. Extensible structure with aluminium finish.

FORME E DIMENSIONI / SHAPES AND DIMENSIONS

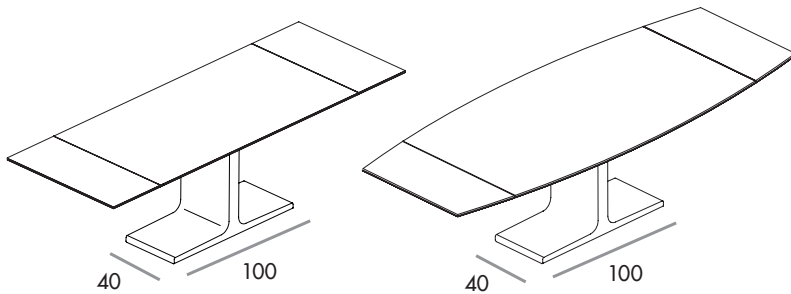

Close 170x90x74h
Open 250x90x74h

Close 200x110x74h
Open 280x110x74h

Close 200x100x74h
Open 280x100x74h

FINITURE STRUTTURA / STRUCTURE FINISHES

Acciaio Inox/Stainless steel



IX

Metallo laccato/Lacquered metal



GB GN GT GC BR

* Top in ceramica laminato: 6 mm ceramica + 8 mm vetro

Laminated ceramic top: 6 mm ceramic + 8 mm glass

FINITURE TOP / TOP FINISHES

VETRO EXTR.
EXTR. GLASS

Lacquered
Cat. B/D

TEB1
TEC1
TEC2
TEC3
TER4
TEV2
TEN1
TEM6
TES1

ACIDATO
FROSTED

Lacquered
Cat. E

AEB1
AEC1
AEC2
AEC3
AER4
AEV2
AEN1
AEM6
AES1

CERAMICA
CERAMIC

CE1

*
CT
CD
CG
CM
CX
CC
CZ

CE2

*
CA
CO
CI
CU
CY
CL
CQ