

# Sistema CUBE: modularità e panche / CUBE system: module range and benches

NOVAMOBILI

design by E-ggs

## Modulo CUBE 1 cassetto / 1-drawer CUBE unit

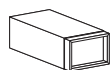

misure L x H x P cm /  
dimensions W x H x D cm

25,5 x 17,4 x 56 kg. 8,4  
51 x 17,4 x 56 kg. 13,5

## Modulo CUBE 1 cassetto con doppia scocca / 1-drawer CUBE module with double carcass

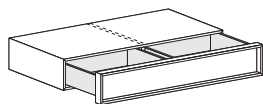

misure L x H x P cm /  
dimensions W x H x D cm

102 x 17,4 x 56 kg. 25,5

## Top vassoio / Tray top

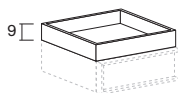

misure L x H x P cm /  
dimensions W x H x D cm

51 x 9,4 x 51 kg. 6  
102 x 9,4 x 51 kg. 12

## Panca CUBE / CUBE bench

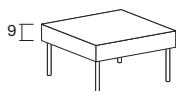

misure L x H x P cm /  
dimensions W x H x D cm

51 x 27,8 x 51 kg. 9  
102 x 27,8 x 51 kg. 18  
153 x 27,8 x 51 kg. 25

## Panca vassoio CUBE / CUBE tray bench

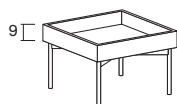

misure L x H x P cm /  
dimensions W x H x D cm

51 x 35 x 51 kg. 9  
102 x 35 x 51 kg. 18

## Panca vassoio CUBE imbottito / Padded CUBE tray bench



misure L x H x P cm /  
dimensions W x H x D cm

51 x 43 x 51 kg. 12  
102 x 43 x 51 kg. 21

## Panca vassoio CUBE L. 51 cm e panca vassoio CUBE imbottito L. 51 cm /

CUBE tray bench  
W 51 cm and padded  
CUBE tray bench  
W 51 cm

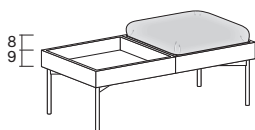

misure L x H x P cm /  
dimensions W x H x D cm

102 x 43 x 51 kg. 21

## Panca vassoio CUBE L. 102 cm e panca vassoio CUBE imbottito L. 51 cm /

CUBE tray bench  
W 102 cm and padded  
CUBE tray bench  
W 51 cm

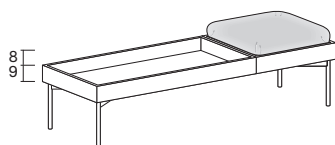

misure L x H x P cm /  
dimensions W x H x D cm

153 x 43 x 51 kg. 27

## Panca vassoio CUBE L. 51 cm e panca vassoio CUBE imbottito L. 102 cm /

CUBE tray bench  
W 51 cm and padded  
CUBE tray bench  
W 102 cm

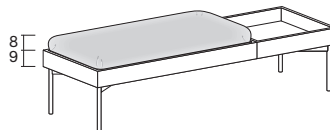

misure L x H x P cm /  
dimensions W x H x D cm

153 x 43 x 51 kg. 30

## Panca vassoio CUBE imbottito L. 102 cm e panca vassoio CUBE imbottito L. 51 cm /

Padded CUBE tray  
bench W 102 cm and  
padded CUBE tray  
bench W 51 cm

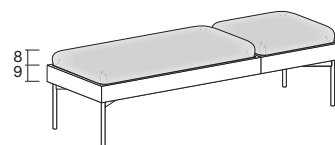

misure L x H x P cm /  
dimensions W x H x D cm

153 x 43 x 51 kg. 33

## ESEMPIO MODULARITÀ / EXAMPLE OF MODULE ARRANGEMENT

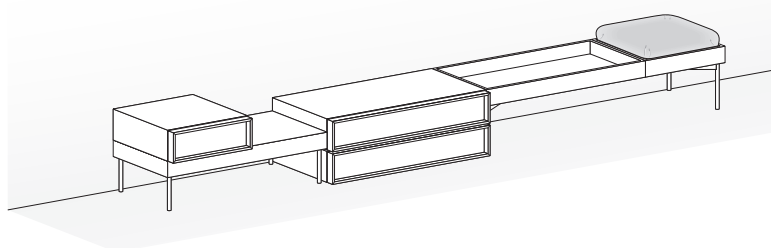

Le informazioni contenute nelle presenti schede tecniche sono indicative. Eventuali differenze con il listino in vigore non costituiscono motivo di contestazione.  
The information given in this technical sheet are indicative. Any discrepancies with the price list currently in force cannot be cause for complaint.

# Sistema CUBE: boiserie e accessori / CUBE system: wall panels and accessories

NOVAMOBILI

design by E-ggs

## Boiserie CUBE / CUBE wall panel

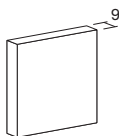

misure L x H x P cm /  
dimensions W x H x D cm

51 x 51 x 9,5	kg. 8
51 x 102 x 9,5	kg. 14
102 x 51 x 9,5	kg. 14
102 x 102 x 9,5	kg. 26

## Boiserie inversa CUBE / CUBE reverse wall panel

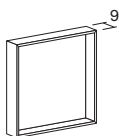

misure L x H x P cm /  
dimensions W x H x D cm

51 x 51 x 9,5	kg. 8
51 x 102 x 9,5	kg. 14
102 x 51 x 9,5	kg. 14
102 x 102 x 9,5	kg. 23

## Boiserie CUBE imbottita / Padded CUBE wall panel

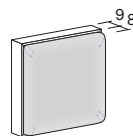

misure L x H x P cm /  
dimensions W x H x D cm

51 x 51 x 17,5	kg. 11
51 x 102 x 17,5	kg. 20
102 x 51 x 17,5	kg. 20
102 x 102 x 17,5	kg. 35

## Boiserie CUBE inversa foderata / Lined reverse CUBE wall panel

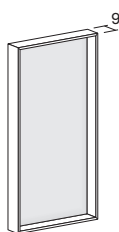

misure L x H x P cm /  
dimensions W x H x D cm

51 x 102 x 9,5	kg. 15,5
102 x 51 x 9,5	kg. 15,5
102 x 102 x 9,5	kg. 26

## Boiserie CUBE con specchiera / CUBE wall panel with mirror



misure L x H x P cm /  
dimensions W x H x D cm

51 x 102 x 9,5	kg. 24
120 x 51 x 9,5	kg. 24

Tutte le boiserie sono dotate di attaccaglie per il fissaggio a muro con sistema antiganciamento. L'ingombro delle attaccaglie crea uno stacco perimetrale dalla parete di 0,5 cm. Assicurarsi preventivamente che la parete sia idonea a sostenere il peso degli elementi pensili nelle condizioni di utilizzo del cliente.

All wall panels come with hanging brackets for wall mounting with accidental release prevention system.

The depth of the hanging brackets means the panels sit 0,5 cm off the wall around the edges. Make sure beforehand that the wall is strong enough to take the weight of wall units under the customer's normal conditions of use.

## Mensola CUBE in metallo / Metal CUBE shelf

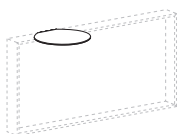

misure L x H x P cm /  
dimensions W x H x D cm

28 x 0,2 x 27,2	kg. 0,5
-----------------	---------

## Mensola CUBE in metallo / Metal CUBE shelf

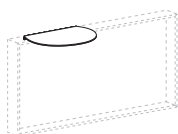

misure L x H x P cm /  
dimensions W x H x D cm

36 x 0,2 x 27,2	kg. 0,6
-----------------	---------

## Appendino CUBE in metallo tornito / Turned metal CUBE coat hook

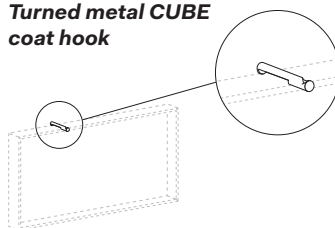

misure L x H x P cm /  
dimensions W x H x D cm

2 x 2 x 14	kg. 0,2
------------	---------

## Tasca rettangolare CUBE in metallo / Metal CUBE rectangular pouch/tray

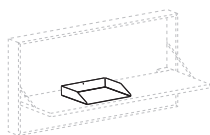
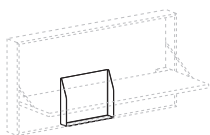

misure L x H x P cm /  
dimensions W x H x D cm

28,5 x 23,5 x 5,2	kg. 2
-------------------	-------

## Tasca triangolare CUBE in metallo / Metal CUBE triangular pouch

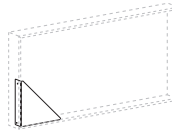

misure L x H x P cm /  
dimensions W x H x D cm

23,5 x 23,5 x 5,2	kg. 1
-------------------	-------

Le informazioni contenute nelle presenti schede tecniche sono indicative. Eventuali differenze con il listino in vigore non costituiscono motivo di contestazione.  
The information given in this technical sheet are indicative. Any discrepancies with the price list currently in force cannot be cause for complaint.

# Sistema CUBE: boiserie uso scrittoi / CUBE system: wall panels desk function

NOVAMOBILI

design by E-ggs

## Boiserie CUBE con scrittoio a ribalta e sospeso / CUBE wall panel with wall-mounted drop-down desk

Chiuso /  
Closed

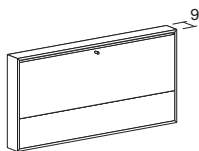

Aperto /  
Open

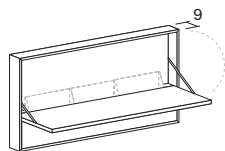

misure L x H x P cm /  
dimensions W x H x D cm

102 x 51 x 39

kg. 25

## Boiserie CUBE con scrittoio / CUBE wall panel with desk

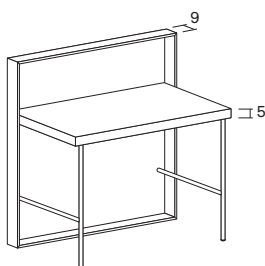

misure L x H x P cm /  
dimensions W x H x D cm

102 x 102 x 63,5

kg. 40

## Boiserie CUBE inversa foderata con scrittoio / Lined reverse CUBE wall panel with desk

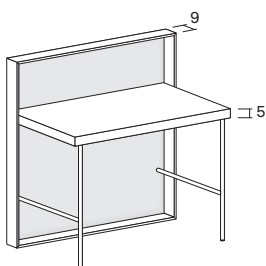

misure L x H x P cm /  
dimensions W x H x D cm

102 x 102 x 63,5

kg. 43

## ESEMPIO MODULARITÀ / EXAMPLE OF MODULE ARRANGEMENT

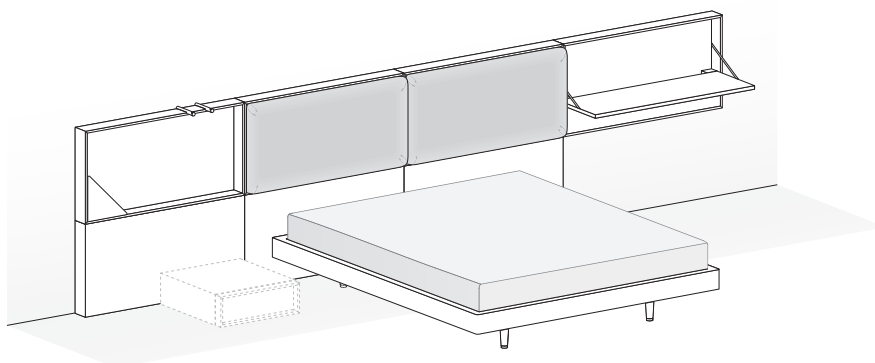

Le informazioni contenute nelle presenti schede tecniche sono indicative. Eventuali differenze con il listino in vigore non costituiscono motivo di contestazione.  
The information given in this technical sheet are indicative. Any discrepancies with the price list currently in force cannot be cause for complaint.

# Sistema CUBE: composizioni per centro stanza / CUBE system: configuration in the middle of the room

NOVAMOBILI

design by E-ggs

## Composizione 1 / Configuration 1

Versione DX /  
RH version

misure L x H x P cm /  
dimensions W x H x D cm

306 x 102 x 116      kg. 213,5

Fronte /  
Front

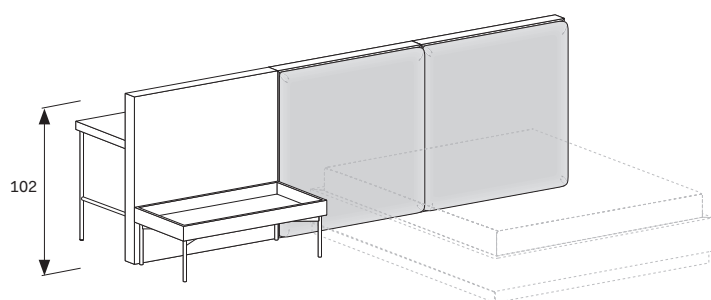

Retro /  
Rear

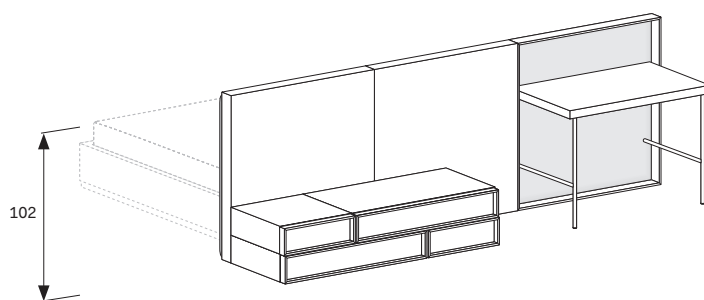

## Composizione 2 / Configuration 2

Versione DX /  
RH version

misure L x H x P cm /  
dimensions W x H x D cm

357 x 102 x 121      kg. 304,46

Fronte /  
Front

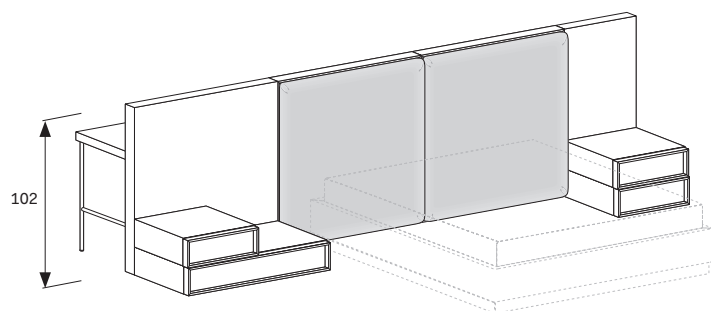

Retro /  
Rear

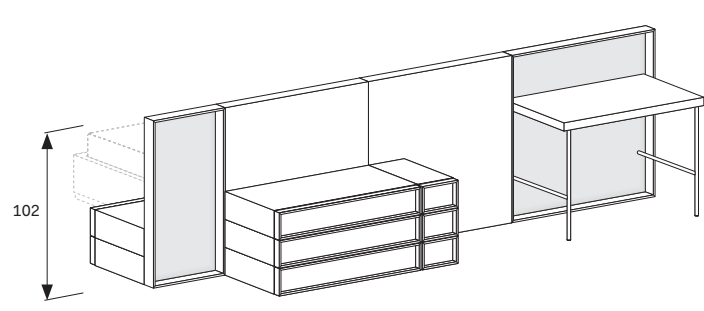

Le informazioni contenute nelle presenti schede tecniche sono indicative. Eventuali differenze con il listino in vigore non costituiscono motivo di contestazione.  
The information given in this technical sheet are indicative. Any discrepancies with the price list currently in force cannot be cause for complaint.